

THE SOLUTION FOR CHANGING LIQUIDS efficiently, clean and safe



THE ORIGINAL



TABLE OF CONTENTS

Femco® Draintechnology.....	3
Applicationlist	4
XL/XL Click drain applicationlist	16
Standard oil drain plug	18
Standard design accessoires.....	23
Compact oil drain plug.....	24
Compact design accessoires.....	29
Click oil drain plug.....	30
Click design accessoires.....	34
Quick oil drain plug.....	36
XL oil drain plug.....	38
XL design accessoires.....	40
XL click oil drain plug.....	41
XL click design accessoires.....	42



Femco Draintechnology B.V.

Rendementsweg 7

3641 SK Mijdrecht

The Netherlands

+31 (0)297 - 23 02 05

info@femco.com

Femco USA Inc.

15321 Main Street NE

Suite 319

Duvall WA 98019

United States

+1 425 318 6050

info@femco.com

Femco[®]
Drain technology is
proud to have its
own manufacturing
based in The
Netherlands.
They produce drain
systems that offer
an efficient, clean
and safe way to
change hot liquids
like engine, gearbox
and hydraulic oil
and coolant.

The drain systems of Femco[®] guarantee that no liquids are spilled during the process and are very easy to operate. The Femco[®] drain plug, made of solid brass, is permanently installed in the liquid reservoir. When it's time to drain the liquid, remove the dustcover, attach the Femco[®] drain connector, the valve opens and the liquid flows straight to the container.

Using their large experience, Femco[®] has developed a standard drain system and four specific systems, each of them focused on several applications.

- **The Standard oil drain plug** works on a wide range of applications. (page 18)
- **The Compact oil drain plug** is the plug with the lowest profile we produce, this is the perfect choice when space is restricted. For example vehicles with a low ground clearance like busses. (page 24)
- **The Click oil drain plug** is the most effective solution for maintenance, and is particularly popular among fleet owners. (page 30)
- **The Quick oil drain plug** is a two-in-one solution that combines a plug with a drain connector and is particularly suitable for fixed machinery. (page 36)
- **The XL oil drain plug** has an optimised flow and is specially developed to drain large volumes in a short time. (page 38)
- **The XL click oil drain plug** is a quick-coupling system which is designed to drain large volumes of oil in a short time. Flow increase of 50%! (page 41)

With all these plugs the application possibilities are unlimited. The drain systems of Femco[®] are used in a wide variety of industries and businesses, like vehicles, earth moving machinery, transport, industry, energy, agriculture and shipping. With a product range covering over 500 thread types and sizes, Femco[®] can quickly respond to customers' requirements. Besides easy, clean and quick use, the drain systems of Femco[®] offer many other interesting advantages to their users:

- The user automatically contributes to a sustainable environment. The product can therefore be part of a company's CSR policy.
- The plug is permanently installed so problems like broken drain plugs or stripped threads are avoided.
- Less liquids are consumed and clothes, hands, floors, etc. don't have to be cleaned as often. The working environment will improve.
- The liquids can be drained without a risk of sand or soil entering the machine. This helps extend the life of the equipment.

APPLICATION LIST

ALLIS CHALMERS

Item number	Thread size		Standard	Click drain	Compact	Quick drain
231, 320, 426 OEM part#: 224994, 205060, 225657, 225585, 74026437, 226408, 4026437	M16X1.5 T10	SB	6090010012	8090010426	7090010161	6190010010
		LB	6090020036	8090020426	7090020184	
301 (2900 Series)	1-1/16-12-UNF-T15	LB	6080020122	8080020490	7080020378	
426T (3500 Series)	¾-14-NPT-T12	LB	6060020144	8060020514	7060020409	
190XT, B, IB, C, CA, RC, WC, WD, WD45, D10, D12, D14, D15, D17, D19, D21, 170 GAS, 175 GAS, 180, 185, 190, 190XT, 200, 210, 220, 6060, 6070, 6080, 7000, 7010, 7020, 8010	7/8"-18 UNF T10	LB	6080020118	8080020488	7080020363	

ALLISON

Item number	Thread size		Standard	Click drain	Compact	Quick drain
VR731, AT545 MT640/3, MT650/3	½-20-UNF-T10	SB	6080010087	8080010477	7080010334	6180010001
		LB	6080020109	8080020477	7080020354	
B300, B400, B500, HYBRID EP40 MD3560P, EP40, 3000, 4000 Series	¾-16-UNF-T15	SB	6080010093	8080010482	7080010340	6180010008
		LB	6080020114	8080020482	7080020359	
6061, 9820	¾-14-NPT-T15	LB	6060020144	8060020520	7060020411	
MT654, HT755DR, HT740	1-11.5-NPT-T12	LB	6060020145	8060020516	7060020413	
HT740RS	7/8-14-UNF-T10	LB	6080020115	8080020483	7080020360	
1000, 2000, 2500	M12x1.75-T9	SB	6090010004	8090010421	7090010153	6190010004
		LB	6090020031	8090020421	7090020170	

BRIGGS & STRATTON

Item number	Thread size		Standard	Click drain	Compact	Quick drain
Small engine	3/8-18-NPT-T10	SB	6060010107	8060010512	7060010352	6160010003
		LB	6060020142	8060020512	7060020407	
Large engine	1/2 -14NPT T12	SB	6060010109	8060010514	7060010354	6160010002
		LB	6060020143	8060020513	7060020408	

APPLICATION LIST

CASE-IH						
Item number	Thread size		Standard	Click drain	Compact	Quick drain
3054, 3056, 3204, 3208, C4.4	¾-16-UNF-T10	SB	6080010092	8080010481	7080010339	6180010007
3116, 3126, C7, C9 side		LB	6080020113	8080020481	7080020358	
3116, 3126, C7, C9 bottom, 305, 359, 504.5, 505CID, MAGNUM SERIES, 5120-9240 w/ Cummins 5.9, 8.3L	M18x1.5 T14	SB	6090010027	8090010433	7090010166	6190010015
		LB	6090020037	8090020477	7090020183	
3176, 3412, 3406, 3408, some 3306 C10, C11, C12, C13, C15, C16, C18 Acert C27 (Pass. Rear, Driver Front)	1 1/8-12UNF T12	LB	6080020124	8080020498	7080020387	
Acert C27 (Driver, Rear, pass. Front)		LB	6080020125	8080020494	7080020372	
3304, 3508, Some 3306	1 ½-12UNF T12	LB	6080020128	8080020496	7080020355	
NPT Plugs	1-11.5NPT T12	LB	6060020145	8060020516	7060020413	
9250-9280, 9350-9390	1-18-UNS-T12	LB	6060020148	8060020519	7050020417	
STX Tractors w/Cummins QSX	M27x2.0 T12	LB	6090020070	8090020458	7090020216	6190010035
OEM: 688067C1, 445097, 41300HA, 359875R1, 445096 D282, D312, D360, D407, DT407, D414, DT414, DT429, D436, DT436, DT466, V800 Case-IH Combine: 1440, 1460, 1480 Case-IH Cotton Picker: 1822, 1844 Case-IH Industrial/Construction: 2656, 2706, 2856, 21026, 21256, 21456 Case IH-Tractor: 100, 130, 140, 154, 230, 240, 275, 330, 340, 350, 354, 384, 400, 404, 414, 424, 434, 444, 450, 454, 460, 464, 504, 544, 560, 574, 600, 606, 650, 656, 660, 666, 674, 686, 706, 756, 766, 806, 826, 856, 886, 966, 986, 1066, 1026, 1086, 1206, 1256, 1456, 1466, 1486, 1566, 1586, 2400, 2404, 2424, 2444, 2500, 2606, 3388, 3414, 3444, 3488, 3588, 3688, 3788, 4100, 4156, 4366, 4386, 4568, 4586, 4786, 5088, 5288, 5488, 6388, 6588, 6788, TD5, Early 500	7/8"-18 UNF T10	LB	6080020118	8080020486	7080020363	

APPLICATION LIST

CATERPILLAR

Item number	Thread size		Standard	Click drain	Compact	Quick drain
All CAT's with tapered pipe plug	1 1/2-11.5NPT T12	LB	6060020145	8060020516	7060020413	
"1100, 1140, 1145, 1150, 1160, 3100, 3116, 3126B, 3126E, C-6, C-7, C-9, 938, 3126, 3208"	3/4-16UNF T15	SB	6080010093	8080010482	7080010340	6180010008
3054, 3056, 3204, 3208, 4.4L	3/4-16 UNF T10	LB	6080020113	8080020481	7080020358	
3176, 3406, 3408, 3412, C10, C11, C12, C13, C14, C15, C16, C18, C30, 3306(some), C27 passenger rear driver front	1-1/8 12UNF T15	LB	6080020123	8080020491	7080020388	
936, 950, 3304, 3508, 3306(some), 3044C	1-1/2 12UNF T12	LB	6080020128	8080020496	7080020355	
3024C, C22, CH3XL2.22TIC,	M16x1.5 T10	SB	6090010029	8090010426	7090010161	6190010010
		LB	6090020036	8090020426	7090020184	
3116, 3126, 3126B, C4, C7, C9 (when plug in on the bottom)	M18x1.5 T14	LB	6090020037	8090020477	7090020183	
CT11-15	M27x2.0 T12	LB	6090020070	8090020458	7090020216	6190010035
CAT745C	1-11-BSP-T12	LB	6070020141	8080020506	7070020401	
C27 ACERT driver rear, passenger front	1-5/16-12UNF T12	LB	6080020125	8080020494	7080020372	

CHEVROLET

Item number	Thread size		Standard	Click drain	Compact	Quick drain
C1500, C20, C10, C2500, C30	1/2-20-UNF T12	SB	6080010085	8080010475	7080010332	
C3500, G10, , G20, G30,		LB	6080020136	8080020512	7080020392	
K10, K1500, K20, K2500, K30, K3500						
R10, R1500, ,R0, R2500, R30, R3500						
Most older Chevy/GMCars trucks						
Most all '90 and newer Chevy/GM cars & trucks	M12x1.75 T10	SB	6090010004	8090010421	7090010153	6190010004
		LB	6090020031	8090020421	7090020170	
Duramax Diesel	M14x1.5 T10	SB	6090010007	8090010423	7090010156	6190010006
		LB	6090020033	8090020423	7090020181	

CONTINENTAL

Item number	Thread size		Standard	Click drain	Compact	Quick drain
Models from 41AL000200	3/4 16 UNF T10	SB	6080010092	8080010481	7080010339	6180010007
		LB	6080020113	8080020481	7080020358	
Engines from W4B00109	7/8-18 UNF T10	LB	6080020118	8080020486	7080020363	
Small pump / genset	3/8-18-NPT-T10	SB	6060010107	8060010512	7060010352	6160010003
		LB	6060020142	8060020512	7060020407	

APPLICATION LIST

CUMMINS						
Item number	Thread size		Standard	Click drain	Compact	Quick drain
ISX, QSX, Sig. 600, QST30, N15	M27x2.0 T12	LB	6090020070	8090020458	7090020216	6190010035
	M27x2.0 T12 o-ring	LB	6090020071	8090020459		
ISM, QSM, L10, M11, N14, 444, 855, QSK50, NTC, NT, NH, 350NT	1-18UNS T12	LB	6060020148	8060020519	7050020417	
5.9L CPL2071, 8.3L	M18x1.5 T14	SB	6090010027	8090010433	7090010166	6190010015
Most ISB, ISC, ISL, 6B, 6C, QSL, ISLG, ISQ, B&C Series, 4BT3.9, 6BT5.9, 8.3L, QSC, 355 Pre 1995, Dodge 5.9L Diesel 2003-2006 Dodge 5.9L Diesel Dodge 6.7L Diesel, QSB (bottom)		LB	6090020037	8090020477	7090020183	
Some, ISB, ISC, ISL, 6B, 6C, QSL Other 6.7L Diesel, 3.3L, 4.5L, QSB (side)	M22x1.5 T10	SB	6090010023	8090010436	7090010172	6190010019
		LB	6090020047	8090020436	7090020195	
VT504, 555, 378V6, QSK	¾-16UNF T10	SB	6080010092	8080010481	7080010339	6180010007
		LB	6080020113	8080020481	7080020358	
1995-2002 Dodge 5.9L Diesel	M22x1.5 T15	SB	6090010026	8090010441	7090010174	6190010021
		LB	6090020049	8090020440	7090020198	
KT1150, QSKT19, KTTA19	1 1/16-12UNF T15	LB	6080020122	8080020490	7080020378	
A2000, A2300	M14x1.5 T10	SB	6090010007	8090010423	7090010156	6190010006
		LB	6090020033	8090020423	7090020181	
QSK 23	M28x1.5 T12	LB				
QSK60, QSK45	M42x2.0 LB T12	LB	6090020075	8090020464	7090020339	

DETROIT DIESEL						
Item number	Thread size		Standard	Click drain	Compact	Quick drain
352, 353, 453, 652, 853, 50 & 60 Series	3/4-14-NPT T15	LB	6060020144	8060020520	7060020411	
6V92, 6V71, 8v92, 8v71, 471T	1/2 -14NPT T12	SB	6060010109	8060010514	7060010354	6160010002
		LB	6060020143	8060020513	7060020408	
DD13, DD15, DD16, 2000, 4000 Series, V8, V12	M27x2.0 T12	LB	6090020070	8090020458	7090020216	6190010035
40 Series	M25x1.5 T15	LB	6090020061	8090020451	7090020210	

DEUTZ						
Item number	Thread size		Standard	Click drain	Compact	Quick drain
FM1008	M12x1.5 T10	SB	6090010003	8090010044	7090010152	6190010009
		LB	6090020030	8090020420	7090020178	
F3L913, F4L913, F6L913, F8L913	M30x1.5 T10	LB	6090020074	8090020463	7090020220	
F3L1011F, F4L1011F, 2011, TCD2012	M18x1.5 T14	SB	6090010027	8090010433	7090010166	6190010015
		LB	6090020037	8090020477	7090020183	
F5L912, F6L912, F3L912	M22x1.5 T10	SB	6090010023	8090010436	7090010172	6190010019
		LB	6090020047	8090020436	7090020195	
W1140, W1450	M16x1.5 T10	SB	6090010012	8090010426	7090010161	6190010010
		LB	6090020036	8090020426	7090020184	

With 600 sizes in stock, if you don't see yours, please contact us for a quote.

APPLICATION LIST

DODGE

Item number	Thread size		Standard	Click drain	Compact	Quick drain
Pre1999 2.7L, 3.2L, 3.3L, 3.5L, 3.8L	½-20-UNF -T10	SB	6080010087	8080010477	7080010334	6180010001
All 3.9L, 5.2L, 5.9L, 3.9L, 8.0L, 8.1L, 8.3L		LB	6080020109	8080020477	7080020354	
1999 + 2.7L, 3.2L, 3.3L, 3.5L, 3.8L	M14x1.5 T10	SB	6090010007	8090010423	7090010156	6190010006
All 1.7L, 1.8L, 2.0L, 2.4L, 2.6L		LB	6090020033	8090020423	7090020181	
All 3.0L, 3.6L, 3.7L, 5.7L, 6.1L						

FORD

Item number	Thread size		Standard	Click drain	Compact	Quick drain
Powerstroke 7.3L, 6.0L, 6.4L, 6.7L	M14x1.25 T10	SB	6090010005	8090010422	7090010154	6190010012
		LB	6090020032	8090020422	7090020180	
1991 + 5.4L, 1993 + 5.8L	M14x1.5 T10	SB	6090010007	8090010423	7090010156	6190010006
1997-2010 5.0L, 7.5L, V10-6.8L		LB	6090020033	8090020423	7090020181	
Duratec 24 valve 3.0L & 3.5L	M12x1.75 T10	SB	6090010004	8090010421	7090010153	6190010004
1996 + 4.2L, 1996 -2003 2.3L		LB	6090020031	8090020421	7090020170	
2.5L SOHC. 1995 + V6-2.5L, 2011 +5.0L						
Pre 1997 5.0L, Pre1993 5.8L	½-20 UNF T10	SB	6080010087	8080010477	7080010334	6180010001
1987-1994 7.3L Diesel		LB	6080020109	8080020477	7080020354	

General Motors

Item number	Thread size		Standard	Click drain	Compact	Quick drain
2.0L, 2.2L, 2.3L, 2.4L, 2.5L	M12x1.75 T10	SB	6090010004	8090010421	7090010153	6190010004
2.9L, 3.1L, 3.4L, 3.5L, 3.7L		LB	6090020031	8090020421	7090020170	
3.9L, 4.2L, 4.9L, 5.3L, 6.0L, 8.1L						
All Pre 1996 2.2L, 2.3L, 3.4L, 3.8L	½-20-UNF -T10	SB	6080010087	8080010477	7080010334	6180010001
4.3L, 5.0L, 5.7L, 6.5L, Diesel, 7.4L		LB	6080020109	8080020477	7080020354	
Duramax Diesel	M14x1.5 T10	SB	6090010007	8090010423	7090010156	6190010006
		LB	6090020033	8090020423	7090020181	

HATZ

Item number	Thread size		Standard	Click drain	Compact	Quick drain
2L31C	M18x1.5 T14	SB	6090010027	8090010433	7090010166	6190010015
		LB	6090020037	8090020477	7090020183	
Supra MO	M22x1.5 T10	SB	6090010023	8090010436	7090010172	6190010019
E Serie	½-14 BSP T10	SB	6070010100	8080010502	7070010348	6170010001

APPLICATION LIST

HINO						
Item number	Thread size		Standard	Click drain	Compact	Quick drain
DS50, EL100, EM100, EP100, E13C	M30x1.5 T10	LB	6090020074	8090020463	7090020220	
H06C, H07C, W04C, EC100	M22x1.5 T10	SB	6090010023	8090010436	7090010172	6190010019
		LB	6090020047	8090020436	7090020195	
F21C, F20C, F17D, K13C W04D, J08E J05C, J08C, S05D, W04D	M18x1.5 T14	SB	6090010027	8090010433	7090010166	6190010015
		LB	6090020037	8090020477	7090020183	

HITACHI						
Item number	Thread size		Standard	Click drain	Compact	Quick drain
1200-6	1-11 BSP T12	LB	6070020141	8080020506	7070020401	
150T with Isuzu engine	M20x1.5-T10	LB	6090020040	8090020430	7090020189	
280T Fuso engine	M18x1.5 T10	LB	6090020038	8090020428	7090020186	

INTERNATIONAL						
Item number	Thread size		Standard	Click drain	Compact	Quick drain
152, 187, 304, 345, 392, 360	½-20UNF T10	SB	6080010087	8080010477	7080010334	6180010001
404, 420 (6.9L), Pre 1995 7.3L		LB	6080020109	8080020477	7080020354	
461, 462, 478, 537, 549, 550, 986	7/8-18UNF T10	LB	6080020118	8080020486	7080020363	
1086, 1486, 1466, D150, D170, D190 Pre 1995 466, 551, DT366 & DT466						
VT275, VT365, T444E, MaxxFace 5 & 7	M14x1.25 T10	SB	6090010005	8090010422	7090010154	6190010012
		LB	6090020032	8090020422	7090020180	
DT360, DT408, DT530 1995-2003 DT466 & DT570 2004-2006 & 2006 w/Vin > 2 million DT466 & DT570 MaxxFace DT, MaxxFace 9, MaxxFace 10 Side plug	M25x1.5 T15	LB	6090020061	8090020451	7090020210	
2007-2009 & 2006 w/Vin < 2 million DT466 & DT570 MaxxFace 10 Bottom plug	M18x1.5 T14	SB	6090010027	8090010433	7090010166	6190010015
		LB	6090020037	8090020477	7090020183	
MAxxFace 11, 13, 15	M27x2.0 T12	LB	6090020070	8090020458	7090020216	6190010035

APPLICATION LIST

ISUZU

Item number	Thread size		Standard	Click drain	Compact	Quick drain
6QA1&2, 6SA1&2, 6RA1, 6RB1 6BF1, 8PA1, 8PB1, 8PC1, DA220 DA640, 12PB1, 10PA1, 10PB2 OPC1, 10PE1, 12PC1, E120, 4L2X DH10H, 4HK1, 4JJ1, 6SB1, Tier3	M24x2.0 T12	LB	6090020057	8090020447	7090020206	
3LB1, 3LD1, 4BD1&2, 4BC2 Tier 2, 4BC1, 4HE1, 4JC1, 4JC2 4JG2, BA1, 6BB1, 6BD1T, 6BG1 6BF1, B Series, HE1, 6HF1, 6HK1 6WG1, G161, C240, 4LE1, 4HK1	M20x1.5 T10	SB LB	6090010018 6090020040	8090010430 8090020430	7090010167 7090020189	6190010016
4BE1, 4BG2, 4JA1, 4JB1 4ZC1, C223, C200	M14x1.5 T10	SB LB	6090010007 6090020033	8090010423 8090020423	7090010156 7090020181	6190010006

IVECO

Item number	Thread size		Standard	Click drain	Compact	Quick drain
Z110, Z120TA, Z220, Z220T, Z230T, Z2340T, Z450T, P85, 6.7L	M22x1.5 T10	SB LB	6090010023 6090020047	8090010436 8090020436	7090010172 7090020195	6190010019

APPLICATION LIST

JOHN DEERE						
Item number	Thread size		Standard	Click drain	Compact	Quick drain
Part# T20098	7/8-20UNF T10	LB	6080020119	8080020487	7080020364	
Part# R26727, 359+, 404, 466, 619, 955CID	1-14UNF T12	LB	6080020121	8080020489	7080020367	
Part# T111565	M16x1.5 T10	SB	6090010012	8090010426	7090010161	6190010010
		LB	6090020036	8090020426	7090020184	
Part# M1746T, 359CID,	7/8-14UNF T10	LB	6080020115	8080020483	7080020360	
Part# R27175, R84262, 496CID, 4*50 & 4*55 SERIES	1 1/16-12UNF T15	LB	6080020122	8080020490	7080020378	
Part# RE523251, RE 46687, R515195	M22x1.5 T10	SB	6090010023	8090010436	7090010172	6190010019
Part# R116102, RE500611, RE507950		LB	6090020047	8090020436	7090020195	
Part# RE 46685, R27474	M18x1.5 T14	SB	6090010027	8090010433	7090010166	6190010015
		LB	6090020037	8090020477	7090020183	
With 855 or L10 Cummins	1-18 UNS T12	LB	6060020148	8060020519	7050020417	
AG TRACTORS: 4755-4960, 7200, 7400, 7600, 7700-7710, 7800-7810, 8100-8420, 8430(new), 9100-9520	1 1/16-12UNF T15	LB	6080020122	8080020490	7080020378	
AG TRACTORS: 3010-3020-, 4000-4020, 4230-4240, 4430-4440, 4620-4630	1-14UNF T12	LB	6080020121	8080020489	7080020367	
AG TRACTORS: 2010, 2040, 2350-55, 2550-55, 2750-2955, 3050-3255, 4030	7/8-14UNF T10	LB	6080020115	8080020483	7080020360	
AG TRACTORS: 301-401, 820-830, 1020, 1070, 1520-1530, 2020-30, 2150, 2240-50, 2440, 2630-40, 6100, 6200, 6300, 6400, 6500	7/8-20UNF T10	LB	6080020119	8080020487	7080020364	
AG TRACTORS: 7310	M27x2.0 T12	LB	6090020070	8090020458	7090020216	6190010035

KOMATSU						
Item number	Thread size		Standard	Click drain	Compact	Quick drain
3D72, 3D72-2BA (SN#1001-3000)	M22x1.5 T10	SB	6090010023	8090010436	7090010172	6190010019
3D75, 3d75N, 3D78, 3D78N		LB	6090020047	8090020436	7090020195	
3D80, 3D84, 3D84N, 4D84						
With Perkins	¾-16-UNF-T10	SB	6080010092	8080010481	7080010339	6180010007
		LB	6080020113	8080020481	7080020358	
S3D84E, 1D75, 1D84, 2T75L, 3D62AE, KDP20T, KDP30T, KDP40T, S3D84	M24x1.5 T15	LB	6090020055	8090020445	7090020204	
2D68E, 3D66, 3D72N, 3D78-1F 3D84N-2AA, 3D84E, 2D75, 3D68E, 3D63						
WA500-3	1-11,5-NPT-T12	LB	6060020145	8060020516	7060020413	

APPLICATION LIST

KUBOTA

Item number	Thread size		Standard	Click drain	Compact	Quick drain
Carrier Refers - ultra Phoenix 134 D1005, D1503, D722, 482, V3300 V3800, V2203, Tripac, Comfort Pro Guard	M22x1.5 T10	SB	6090010023	8090010436	7090010172	6190010019
		LB	6090020047	8090020436	7090020195	
D600, D750, D850, D950, D1102, D1302 D1402, F2302, S2600, S2800, V1100 V1502, V1505, V1702, V1902, V4300, Z8600C Z400, Z500, Z751, Z851, ZB-600C, D905E	M12x1.25 T10	SB	6090010002	8090010049	7090010151	6190010001
		LB	6090020029	8090020419	7090020177	
D782, V1903, V2003, Z600BM	M16x1.5 T10	SB	6090010012	8090010426	7090010161	6190010010
		LB	6090020036	8090020426	7090020184	

LISTER PETTER

Item number	Thread size		Standard	Click drain	Compact	Quick drain
Delta Series, X Range series	M14x1.5 T10	SB	6090010007	8090010423	7090010156	6190010006
		LB	6090020033	8090020423	7090020181	
LAP3, LPWS4	½-14 BSP T10	SB	6070010100	8080010502	7070010348	6170010001
		LB	6070020132	8080020502	7070020397	
CRK3	3/8-19 BSP T10	SB	6070010131	8080010501	7070010347	6170010008
		LB	6070020131	8080020501	7070020396	

MACK

Item number	Thread size		Standard	Click drain	Compact	Quick drain
E3, EC3, EC5, E6	7/8-14UNF T10	LB	6080020115	8080020483	7080020360	
ASET, E7, CHC, 350	M20x1.5 T10	SB	6090010018	8090010430	7090010167	6190010016
		LB	6090020040	8090020430	7090020189	
M200, M250, CS200, CS250	M36x2.0 T12	LB	6090020082	8090020471	7090020337	
MP7, MP8, MP10, Midliner	M24x1.5 T15	LB	6090020055	8090020445	7090020204	
E9	½-14NPT T12	SB	6060010109	8060010514	7060010354	6160010002
		LB	6060020143	8060020513	7060020408	

APPLICATION LIST

MERCEDES						
Item number	Thread size		Standard	Click drain	Compact	Quick drain
Older Trucks & bus engines	M26x1.5 T10	LB	6090020063	8090020452	7090020212	
Up to 2005 MBE 4000 (S/N<833529)	M26x1.5 T10 (47L)	LB	6090020066	8090020455		
MBE 4000 (S/N> 833529)	M22x1.5 T10	SB	6090010023	8090010436	7090010172	6190010019
MBE 900/906, OM 460, 926		LB	6090020047	8090020436	7090020195	
Actros	M20x1.5 T15	LB	6090020044	8090020432		
Atego	M24x1,5 T12	LB	6090020054	8090020444	7090020203	
Atego, OM441LA, OM457hLA, om906hLA, OM457LA	M26x1.5 T10	LB	6090020063	8090020452	7090020212	
OM502LA	M20x1.5 T10	LB	6090020040	8090020430	7090020189	
OM612DE27LA, OM611DELA euro2, OM642DE30LA, OM651DE22LA, OM646DE22LA	M14x1.5 T10	LB	6090020033	8090020423	7090020181	

MITSUBISHI						
Item number	Thread size		Standard	Click drain	Compact	Quick drain
4P10	M22x1.5 T10	SB	6090010023	8090010436	7090010172	6190010019
		LB	6090020047	8090020436	7090020195	
6D14-2AT, 6D1402A, K4E, 4G54, 6D24	M18x1.5 T14	SB	6090010027	8090010433	7090010166	6190010015
		LB	6090020037	8090020477	7090020183	
S62E	M16x1.5 T10	SB	6090010012	8090010426	7090010161	6190010010
		LB	6090020036	8090020426	7090020184	
S4	M14x1.5 T10	SB	6090010007	8090010423	7090010156	6190010006
		LB	6090020033	8090020423	7090020181	

NISSAN INDUSTRIAL						
Item number	Thread size		Standard	Click drain	Compact	Quick drain
PX6,PX7, PX8, PX9	M18x1.5 T14	SB	6090010027	8090010433	7090010166	6190010015
		LB	6090020037	8090020477	7090020183	
MX	M26x1.5 T10	LB	6090020063	8090020452	7090020212	

PACCAR						
Item number	Thread size		Standard	Click drain	Compact	Quick drain
MX	M26x1.5 T10	LB	6090020063	8090020452	7090020212	
PX6,PX8	M18x1.5 T14	SB	6090010027	8090010433	7090010166	6190010015
		LB	6090020037	8090020477	7090020183	

APPLICATION LIST

PERKINS

Item number	Thread size		Standard	Click drain	Compact	Quick drain
Most (including forklifts), 6.6L, 1106, 1000 SERIES	¾-16-UNF-T10	SB	6080010092	8080010481	7080010339	6180010007
		LB	6080020113	8080020481	7080020358	
2 Cyl, Ringmaster	M12x1.25 T10	SB	6090010002	8090010049	7090010151	6190010001
		LB	6090020029	8090020419	7090020177	
4 Cyl,	M16x1.5 T10	SB	6090010012	8090010426	7090010161	6190010010
		LB	6090020036	8090020426	7090020184	

SCANIA

Item number	Thread size		Standard	Click drain	Compact	Quick drain
P280B 6X2*4	M24x2.0 T21 47L	LB	6090020058			
No insert	M30x1.5 T10	LB	6090020074	8090020463	7090020220	
With insert	M24x2.0 T12	LB	6090020057	8090020447	7090020206	

SISU

Item number	Thread size		Standard	Click drain	Compact	Quick drain
Tractor	M18x1.5 T14	SB	6090010027	8090010433	7090010166	6190010015
		LB	6090020037	8090020477	7090020183	

TEREX-DEMAG

Item number	Thread size		Standard	Click drain	Compact	Quick drain
CC2400 (Mercedes engine)	M26x1.5 T10	LB	6090020063	8090020452	7090020212	

THERMOKING

Item number	Thread size		Standard	Click drain	Compact	Quick drain
Yanmar & Isuzu	¾-14NPT T15	LB	6060020144	8060020520	7060020411	
	½-14 NPT T12	LB	6060020143	8060020513	7060020408	

TOYOTA

Item number	Thread size		Standard	Click drain	Compact	Quick drain
2G, 1Z, 1DZ, 2D, 2F, 2H	M25x1.5 T15	LB	6090020061	8090020451	7090020210	
4D, 5R	M18x1.5 T14	SB	6090010027	8090010433	7090010166	6190010015
		LB	6090020037	8090020477	7090020183	
4Y	M12x1.25 T10	SB	6090010002	8090010049	7090010151	6190010001
		LB	6090020029	8090020419	7090020177	

APPLICATION LIST

VOLVO						
Item number	Thread size		Standard	Click drain	Compact	Quick drain
TD Models, F6, F7, F86, N10.12, Penta	7/8-14UNF T10	LB	6080020115	8080020483	7080020360	
Grader	M32x1.5 T12	LB	6090020078	8090020467	7090020222	
F12, FH12, D7, D11, D12, D13, D16 D13A, D16C, D16C7, D11C, D11A, D13C	M24x1.5 T15	LB	6090020055	8090020445	7090020204	
FH16	M24x2.0 T12	LB	6090020057	8090020447	7090020206	

YANMAR						
Item number	Thread size		Standard	Click drain	Compact	Quick drain
1GM10, 3TN75EG2, 3TN82ES, 3TM75ES 3TN75EG1, 3TN8EG1, 3TNA72ES 3TNA72EG2, 3TN82EG2, 4TN85TEG2 4tN85TES, 4TN82TEG1, 3TNV88, 3TNE74 3TNV84T, 4TNV88, 4TNV98, 4TN498, 4TNV84T 4TN82TES, TN82TEG2	M22x1.5 T10	SB LB	6090010023 6090020047	8090010436 8090020436	7090010172 7090020195	6190010019
TS50, T50C, TS60, TS60C, TS70, TS80 TS80C, TS105, TS105C, 2T72HLE 2TNV88, 3TNV70, 3TNV74, 3TNV76 3TNV82, 2T90LE, 3T80LE, 3T90LE 75HLE, 3T84HLE, 2T90E, 3TN663S 3TN66EG2, 4PH-ME, PHMTE	M16x1.5 T10	SB LB	6090010012 6090020036	8090010426 8090020426	7090010161 7090020184	6190010010
6LY-UTE, 6CX-ETE, 6PH-ME 3T95LE, 4T95LE, 4T95LTE	M20x1.5 T10 M24x2.0 T12	SB LB LB	6090010018 6090020040 6090020057	8090010430 8090020430 8090020447	7090010167 7090020189 7090020206	6190010016

XL/XL CLICK DRAIN APPLICATION LIST

ALLIS CHALMERS				
Item number	Thread size		XL Standard	XL Click drain
301 (2900 Series)	1-1/16-12-UNF-15	LB	5080021116	8180020492

ALLISON				
Item number	Thread size		XL Standard	XL Click drain
MT654 , HT755DR , HT740	1-11.5-NPT-T12	LB	5060021115	8160021115

CASE-IH				
Item number	Thread size		XL Standard	XL Click drain
3176 , 3412 , 3406 , 3408 , some 3306 C10 , C11 , C12 , C13 , C15 , C16 , C18 Acert C27 (Pass. Rear, Driver Front)	1 1/8-12UNF T12	LB	5080021181	8180021181
Acert C27 (Driver, Rear, pass. Front)	1 5/16-12UNF T12	LB	5080021516	8180021516
3304 , 3508 , Some 3306	1 1/2-12UNF T12	LB	5080021120	8180021120
NPT Plugs	1-11.5NPT T12	LB	5060021115	8160021115
STX Tractors w/Cummins QSX	M27x2.0 T12	LB	5090020272	8190020272

CATERPILLAR				
Item number	Thread size		XL Standard	XL Click drain
All CAT's with tapered pipe plug	1 11.5NPT T12	LB	5060021115	8160021115
3176, 3406, 3408, 3412, C10, C11, C12, C13, C14, C15, C16, C18, C30, 3306(some), C27 passenger rear driver front	1-1/8 12UNF T15	LB	5080021180	8180020491
936, 950, 3304, 3508, 3306(some), 3044C	1-1/2 12UNF T12	LB	5080021120	8180021120
CT11-15	M27x2.0 T12	LB	5090020272	8190020272
CAT745C	1-11-BSP-T12	LB	5070021111	8170021111
C27 ACERT driver rear, passenger front	1-5/16-12UNF T12	LB	5080021516	8180021516

CUMMINS				
Item number	Thread size		XL Standard	XL Click drain
ISX, QSX , Sig. 600 , QST30 , N15	M27x2.0 T12	LB	5090020272	8190020272
	M27x M2.0 T12 o-ring	LB	5090020273	8190020273
KT1150 , QSKT19, KTTA19	1 1/16-12UNF T15	LB	5080021116	8180020492

DETROIT DIESEL				
Item number	Thread size		XL Standard	XL Click drain
DD13, DD15, DD16, 2000, 4000 Series, V8, V12	M27x2.0 T12	LB	5090020272	8190020272

XL/XL CLICK DRAIN APPLICATION LIST

DEUTZ				
Item number	Thread size		XL Standard	XL Click drain
F3L913, F4L913, F6L913, F8L913	M30x1.5 T10	LB	5090020301	8190020301

HINO				
Item number	Thread size		XL Standard	XL Click drain
DS50, EL100, EM100, EP100, E13C	M30x1.5 T10	LB	5090020301	8190020301

HITACHI				
Item number	Thread size		XL Standard	XL Click drain
1200-6	1-11 BSP T12	LB	5070021111	817002111

INTERNATIONAL				
Item number	Thread size		XL Standard	XL Click drain
MAxxForce 11, 13, 15	M27x2.0 T12	LB	5090020272	8190020272

JOHN DEERE				
Item number	Thread size		XL Standard	XL Click drain
Part# R27175, R84262, 496CID, 4*50 & 4*55 SERIES	1 1/16-12UNF T15	LB	5080021116	8180020492
AG TRACTORS: 4755-4960, 7200, 7400, 7600, 7700-7710, 7800-7810, 8100-8420, 8430(new), 9100-9520	1 1/16-12UNF T15	LB	5080021116	8180020492
AG TRACTORS: 7.310	M27x2.0 T12	LB	5090020272	8190020272

KOMATSU				
Item number	Thread size		XL Standard	XL Click drain
WA500-3	1-11,5-NPT-T12	LB	5060021115	8160021115

SCANIA				
Item number	Thread size		XL Standard	XL Click drain
No insert	M30x1.5 T10	LB	5090020301	8190020301

VOLVO				
Item number	Thread size		XL Standard	XL Click drain
Grader	M32x1.5 T12	LB	5090020322	8190020322

PRODUCTS

STANDARD OIL DRAIN PLUG

In 1983 Femco® introduced the Standard plug to make routine oil changes a quick, clean and more environmentally friendly job. The Standard plug is manufactured out of 100% brass, which makes it easy to change hot oil*. Additionally, the oil drain plug features a dust cover and a double O-ring, which protects the plug and ensures reliable performance.



HOW TO DRAIN YOUR OIL (OR OTHER FLUIDS)

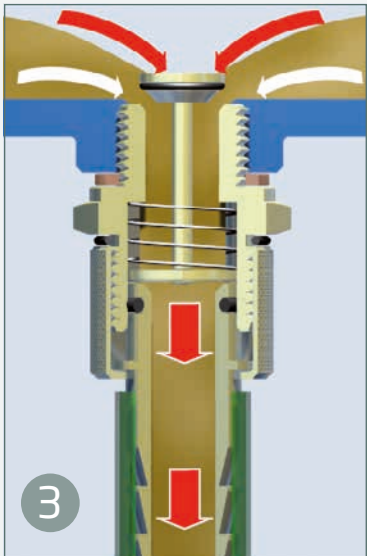
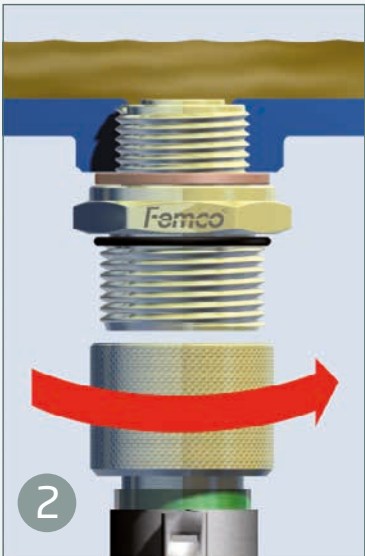
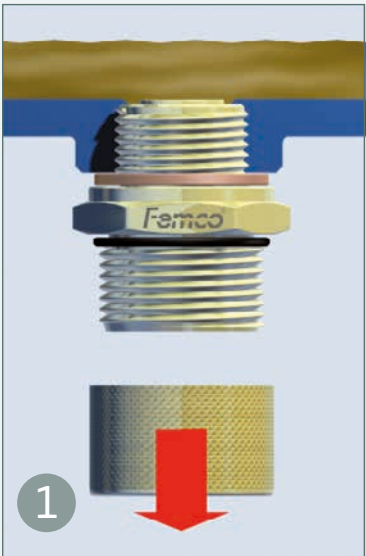

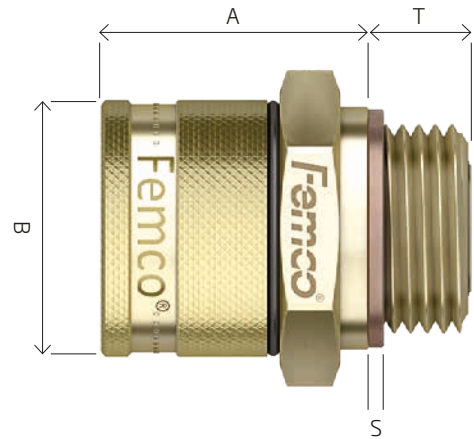
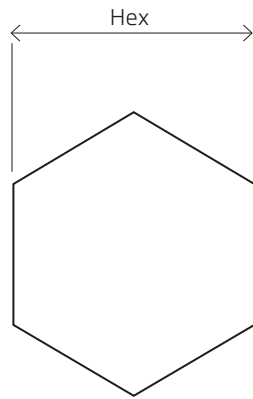

METR. SIZES						
Thread size	Item number	T	A	B	S	Hex
M12x1.25	6090020029	10	32	30	2	30
M12x1.5	6090020030	10	32	30	2	30
M12x1.75	6090020031	10	32	30	2	30
M14x1.25	6090020032	10	32	30	2	30
M14x1.5	6090020033	10	32	30	2	27
M16x1.5	6090020036	10	32	30	2	27
M18x1.5	6090020037	14	28	30	2	27
M18x1.5	6090020038	10	32	30	2	27
M20x1.5	6090020040	10	32	30	2	30
M20x1.5	6090020044	15	32	30	2	30
M22x1.5	6090020047	10	32	30	2	30
M22x1.5	6090020049	15	32	30	2	30
M24x1.5	6090020053	10	32	30	2	30
M24x1.5	6090020054	12	30	30	2	30
M24x1.5	6090020055	15	28	30	2	30
M24x2.0	6090020057	12	30	30	2	30
M24x2.0	6090020058	21	30	30	2	30
M25x1.5	6090020061	15	27	30	2	32
M26x1.5	6090020063	10	32	30	2	32
M26x1.5	6090020066	10	37	30	2	32
M27x2.0	6090020070	12	42	30	2	32
M27x2.0 + o-ring	6090020071	12	30	30	o-ring	32
M28x1.5	6090020075	12	32	30	2	36
M30x1.5	6090020074	10	32	30	2	36
M32x1.5	6090020078	12	32	30	2	50
M42x2.0	6090020090	12	32	30	2	46

NPT						
Thread size	Item number	T	A	B	S	Hex
3/8"-18 NPT	6060020142	10	32	30	n/a	30
1/2"-14 NPT	6060020143	12	30	30	n/a	30
3/4"-14 NPT	6060020144	15	27	30	n/a	32
1"-11,5 NPT	6060020145	12	30	30	n/a	36

UNF						
Thread size	Item number	T	A	B	S	Hex
1/2"-20 UNF	6080020109	10	32	30	2	30
1/2"-20 UNF	6080020136	12	32	30	2	30
3/4"-16 UNF	6080020113	10	30	30	2	30
3/4"-16 UNF	6080020114	15	32	30	2	30
7/8"-14 UNF	6080020115	10	32	30	2	30
7/8"-18 UNF	6080020118	10	32	30	2	30
7/8"-20 UNF	6080020119	10	32	30	2	30
1"-14 UNF	6080020121	12	30	30	2	32
1" 1/16-12 UNF	6080020122	15	30	30	2	32
1" 1/8-12 UNF	6080020123	15	27	30	2	36
1" 1/8-12 UNF	6080020124	12	27	30	2	36
1" 5/16-12 UNF	6080020125	12	32	30	2	36
1" 1/2-12 UNF	6080020128	12	30	30	2	46

BSP						
Thread size	Item number	T	A	B	S	Hex
3/8"-19 BSP	6070020131	10	32	30	2	30
1/2"-14 BSP	6070020132	10	32	30	2	30
1"-11 BSP	6070020141	12	30	30	2	36

UNS						
Thread size	Item number	T	A	B	S	Hex
1"-18 UNS	6060020148	12	30	30	2	32

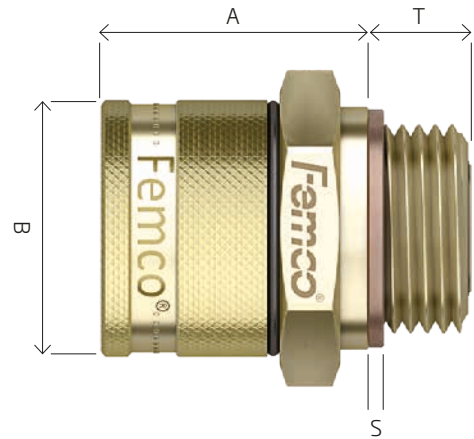
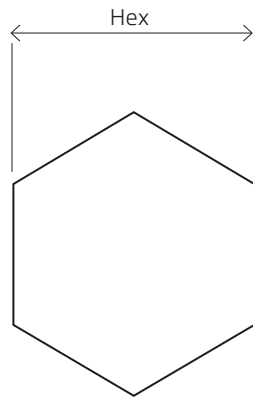

METR. SIZES						
Thread size	Item number	T	A	B	S	Hex
M12x1.25	6090010002	9	27	25	2	22
M12x1.5	6090010003	9	27	25	2	22
M12x1.75	6090010004	9	27	25	2	22
M14x1.25	6090010005	9	27	25	2	22
M14x1.5	6090010007	9	27	25	2	22
M16x1.5	6090010012	9	27	25	2	22
M16x1.5	6090010013	12	27	25	2	27
M18x1.5	6090010027	14	27	25	2	22
M18x1.5	6090010015	12	27	25	2	24
M20x1.5	6090010018	10	27	25	2	27
M22x1.5	6090010023	10	27	25	1,5	27
M22x1.5	6090010024	12	27	25	1,5	27
M22x1.5	6090010026	15	27	25	1,5	27

NPT						
Thread size	Item number	T	A	B	S	Hex
3/8"-18 NPT	6060010107	10	27	25	n/a	22
1/2"-14 NPT	6060010109	12	25	25	n/a	27

UNF						
Thread size	Item number	T	A	B	S	Hex
1/2"-20 UNF	6080010085	12	25	25	2	25
1/2"-20 UNF	6080010087	10	27	25	2	22
3/4"-16 UNF	6080010092	10	27	25	2	27
3/4"-16 UNF	6080010093	15	27	25	2	27

BSP						
Thread size	Item number	T	A	B	S	Hex
3/8"-19 BSP	6070010103	9	28	25	2	22
1/2"-14 BSP	6070010100	10	27	25	2	27



STANDARD DESIGN

ACCESSOIRES

DESCRIPTION	THREAD SIZE		ITEM NUMBER	A	B	C	D
Straight Drainer	M22 x 1,5	SB	650117	25	17	22	15
Straight Drainer with hose 25cm	M22 x 1,5	SB	650100				
Straight Drainer with hose 130cm	M22 x 1,5	SB	650101				
Straight Drainer	M26 x 1,5	LB	650118	30	20	28	19
Straight Drainer with hose 25cm	M26 x 1,5	LB	650103				
Straight Drainer with hose 130cm	M26 x 1,5	LB	650104				

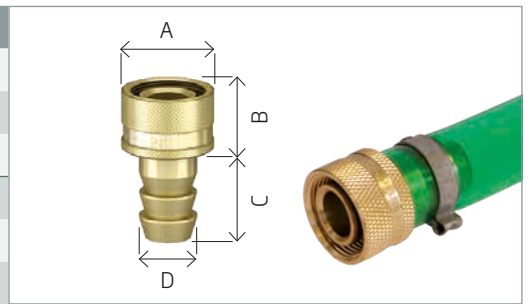

DESCRIPTION	THREAD SIZE		ITEM NUMBER	A	B	C	D	E
Angled drainer 90°	M22 x 1,5	SB	650119	25	17	37	34	15
Angled drainer 90° with hose 25cm	M22 x 1,5	SB	650106					
Angled drainer 90° with hose 130cm	M22 x 1,5	SB	650107					
Angled drainer 90	M26 x 1,5	LB	650120	30	20	40	37	19
Angled drainer 90 with hose 25cm	M26 x 1,5	LB	650108					
Angled drainer 90 with hose 130cm	M26 x 1,5	LB	650109					

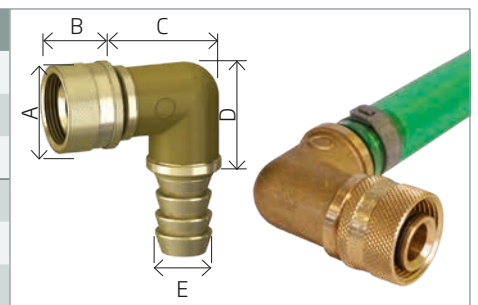

DESCRIPTION	THREAD SIZE		ITEM NUMBER	A	B	C
Angled drainer 45°	M22 x 1,5	SB	650127	25	65	19
Angled drainer 45° with hose 25cm	M22 x 1,5	SB	650114			
Angled drainer 45° with hose 40cm	M22 x 1,5	SB	650115			
Angled drainer 45°	M26 x 1,5	LB	650123	30	65	19
Angled drainer 45° with hose 25cm	M26 x 1,5	LB	650121			
Angled drainer 45° with hose 130cm	M26 x 1,5	LB	650122			

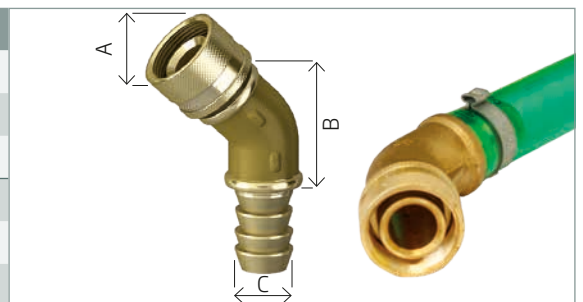



DESCRIPTION		ITEM NUMBER	
Dustcap	SB	650112	
Dustcap	LB	650113	

DESCRIPTION		ITEM NUMBER	
SB Clamp	1/2"	951004	
SB Hose	25cm	951002	

DESCRIPTION		ITEM NUMBER	
Dustcap-set	SB	650116	
Dustcap-set	LB	650135	

DESCRIPTION		ITEM NUMBER	
LB Clamp	3/4"	951005	
LB Hose	25cm	951001	

DESCRIPTION		ITEM NUMBER	
Sampling nipple	SB	951006	
Sampling nipple	LB	951007	

DESCRIPTION		ITEM NUMBER	
Chain + Clip		951003	

DESCRIPTION		ITEM NUMBER	
Sealing cap for Drainer	LB	650137	

DESCRIPTION		ITEM NUMBER	
Sealing plug for drainer hose	LB	650138	

PRODUCTS

COMPACT OIL DRAIN PLUG

The Compact Drain is the plug with the lowest profile we produce and is the perfect choice for oil changes in tight spaces. The Compact plug only extends 12 millimetres from the sump/oil pan. This makes it especially suitable for vehicles with a low ground clearance.



HOW TO DRAIN YOUR OIL (OR OTHER FLUIDS)

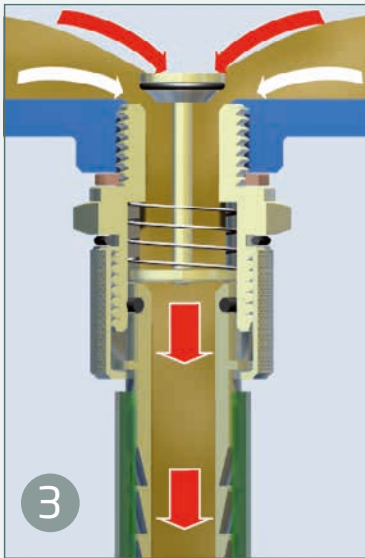
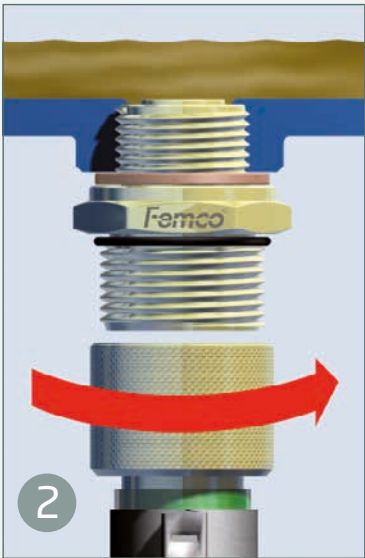
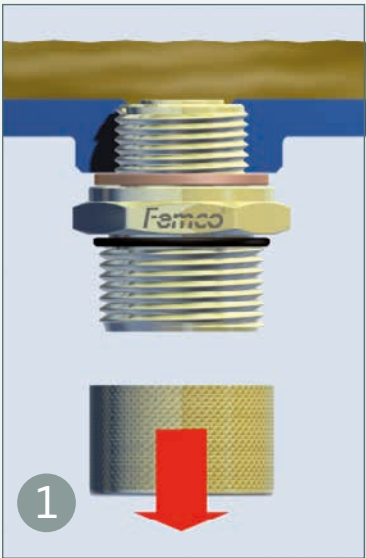

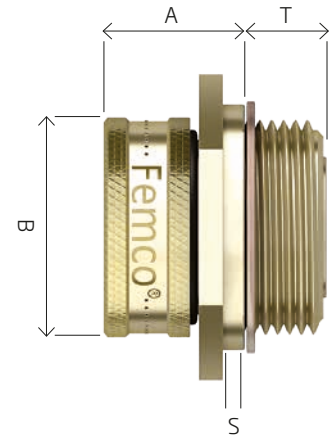
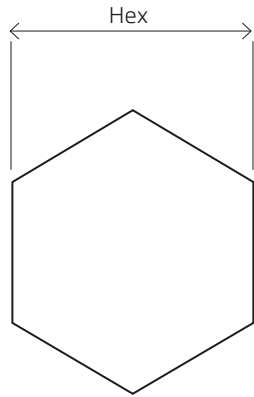

METR. SIZES						
Thread size	Item number	T	A	B	S	Hex
M12x1.25	7090020177	10	12	28	2	30
M12x1.5	7090020178	10	12	28	2	30
M12x1.75	7090020170	10	12	28	2	30
M14x1.25	7090020180	10	12	28	2	30
M14x1.5	7090020181	10	12	28	2	30
M16x1.5	7090020184	10	12	28	2	30
M18x1.5	7090020186	10	12	28	2	30
M18x1.5	7090020183	14	14	28	2	30
M20x1.5	7090020189	10	12	28	2	30
M22x1.5	7090020195	10	12	28	2	30
M22x1.5	7090020198	15	12	28	2	30
M24x1.5	7090020203	12	12	28	2	30
M24x1.5	7090020204	15	12	28	2	30
M24x2.0	7090020206	12	15	28	2	30
M25x1.5	7090020210	15	12	28	2	32
M26x1.5	7090020212	10	12	28	2	32
M27x2.0	7090020216	12	15	28	2	32
M30x1.5	7090020220	10	12	28	2	36
M32x1.5	7090020222	12	12	28	2	36
M36x2.0	7090020336	12	15	28	2	42

NPT						
Thread size	Item number	T	A	B	S	Hex
3/8-18 NPT	7060020407	10	12	28	n/a	30
1/2-14 NPT	7060020408	12	12	28	n/a	30
3/4-14 NPT	7060020411	15	12	28	n/a	32
3/4-14 NPT	7060020409	12	16	28	n/a	32
1 1/2-11.5 NPT	7060020413	12	15	28	n/a	36

UNF						
Thread size	Item number	T	A	B	S	Hex
½-20 UNF	7080020354	10	13	28	2	30
½-20-UNF	7080020392	12	13	28	2	30
¾ 16 UNF	7080020358	10	13	28	2	30
¾-16 UNF	7080020359	15	12	28	2	30
7/8-14 UNF	7080020360	10	13	28	2	30
7/8-18 UNF	7080020363	10	13	28	2	30
7/8-20 UNF	7080020364	10	14	28	2	30
1-14 UNF	7080020367	12	15	28	2	32
1 1/8-12 UNF	7080020387	12	14	28	2	32
1-1/16-12 UNF	7080020377	12	15	28	2	32
1 5/16-12 UNF	7080020372	12	15	28	2	36
1 ½-12 UNF	7080020355	12	14	28	2	46

BSP						
Thread size	Item number	T	A	B	S	Hex
½-14 BSP	7070020397	10	12	28	2	30
3/8-19 BSP	7070020396	10	14	28	2	30
1-11 BSP	7070020401	12	14	28	2	36

UNS						
Thread size	Item number	T	A	B	S	Hex
1-18 UNS	7050020417	12	15	28	2	32

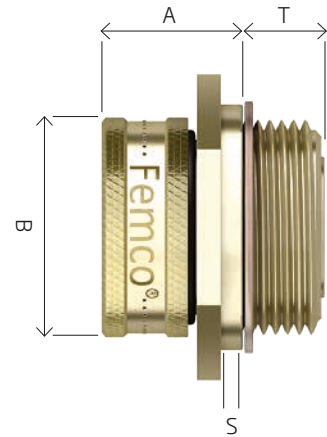
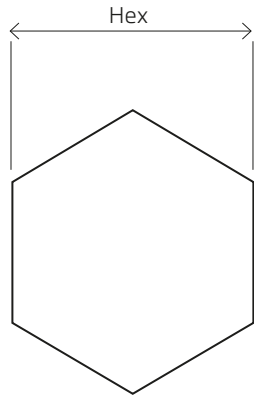

METR. SIZES						
Thread size	Item number	T	A	B	S	Hex
M12x1.25	7090010151	9	12	24	2	22
M12x1.5	7090010152	9	12	24	2	22
M12x1.75	7090010153	9	12	24	2	22
M14x1.25	7090010154	9	12	24	2	22
M14x1.5	7090010156	9	12	24	2	22
M16x1.5	7090010161	9	12	24	2	22
M18x1.5	7090010166	14	12	24	2	27
M20x1.5	7090010167	10	12	24	2	27
M22x1.5	7090010172	10	12	24	2	27
M22x1.5	7090010174	15	12	24	2	27

NPT						
Thread size	Item number	T	A	B	S	Hex
½-14 NPT	7060010354	12	12	24	n/a	27
¾-18 NPT	7060010352	9	12	24	n/a	24

UNF						
Thread size	Item number	T	A	B	S	Hex
½-20 UNF	7080010334	9	12	24	2	22
½-20 UNF	7080010332	12	12	24	2	22
¾-16 UNF	7080010339	10	12	24	2	24
¾-16 UNF	7080010340	15	12	24	2	24

BSP						
Thread size	Item number	T	A	B	S	Hex
¾-19 BSP	7070010347	9	12	24	2	22
½-14 BSP	7070010348	10	12	24	2	27



COMPACT DESIGN

ACCESSOIRES

DESCRIPTION	THREAD SIZE		ITEM NUMBER	A	B	C	D
Straight Drainer	M20x1.25	SB	750003	25	19	24	15
Straight Drainer with hose 25cm	M20x1.25	SB	750001				
Straight Drainer with hose 130cm	M20x1.25	SB	750002				
Straight Drainer	M24x1.25	LB	750007	30	20	28	19
Straight Drainer with hose 25cm	M24x1.25	LB	750005				
Straight Drainer with hose 130cm	M24x1.25	LB	750006				

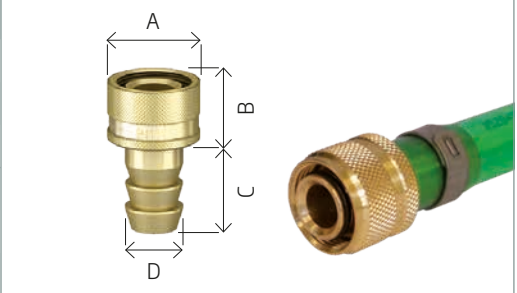

DESCRIPTION	THREAD SIZE		ITEM NUMBER	A	B	C	D	E
Angled drainer 90°	M20x1.25	SB	750009	25	17	37	34	15
Angled drainer 90° with hose 25cm	M20x1.25	SB	750004					
Angled drainer 90° with hose 130cm	M20x1.25	SB	750008					
Angled drainer 90	M24x1.25	LB	750012	30	20	40	37	19
Angled drainer 90 with hose 25cm	M24x1.25	LB	750010					
Angled drainer 90 with hose 130cm	M24x1.25	LB	750011					

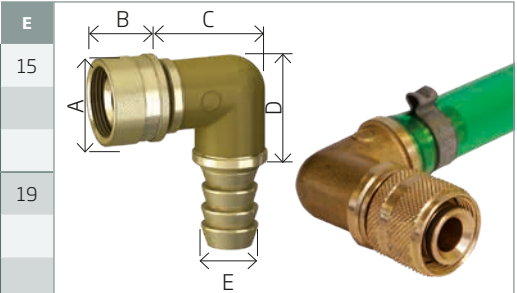

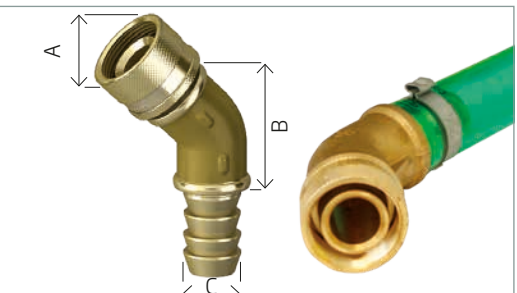

DESCRIPTION	THREAD SIZE		ITEM NUMBER	A	B	C
Angled drainer 45°	M20x1.25	SB	750040	25	65	19
Angled drainer 45° with hose 25cm	M20x1.25	SB	750024			
Angled drainer 45° with hose 130cm	M20x1.25	SB	750041			
Angled drainer 45°	M24x1.25	LB	750026	30	65	19
Angled drainer 45° with hose 25cm	M24x1.25	LB	750013			
Angled drainer 45° with hose 130cm	M24x1.25	LB	750014			



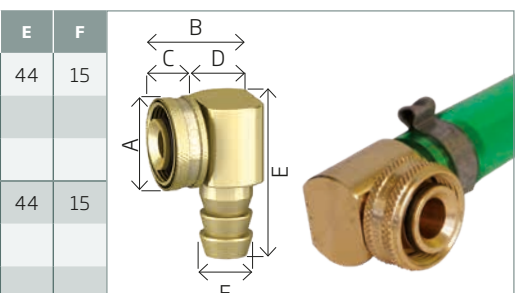

DESCRIPTION	THREAD SIZE		ITEM NUMBER	A	B	C	D	E	F
Angled drainer 90°	M20x1.25	SB	750029	23	30	10	16	44	15
Angled drainer 90° with hose 25cm	M20x1.25	SB	750030						
Angled drainer 90° with hose 130cm	M20x1.25	SB	750031						
Angled drainer 90	M24x1.25	LB	750032	28	30	10	16	44	15
Angled drainer 90 with hose 25cm	M24x1.25	LB	750033						
Angled drainer 90 with hose 130cm	M24x1.25	LB	750034						



DESCRIPTION		ITEM NUMBER	
Dustcap	SB	750027	
Dustcap	LB	750028	

DESCRIPTION		ITEM NUMBER	
SB Clamp	1/2"	951004	
SB Hose	25cm	951002	

DESCRIPTION		ITEM NUMBER	
Sampling nipple	SB	951009	
Sampling nipple	LB	951008	

DESCRIPTION		ITEM NUMBER	
LB Clamp	3/4"	951005	
LB Hose	25cm	951001	

PRODUCTS

CLICK OIL DRAIN PLUG

The Click Drain is the quickest solution for maintenance of your vehicles and machines. The Click Drain oil drain system consists of an oil drain plug and a clicker. When it is time for an oil change you simply click the Clicker onto the oil drain plug to start draining the oil.



HOW TO DRAIN YOUR OIL (OR OTHER FLUIDS)

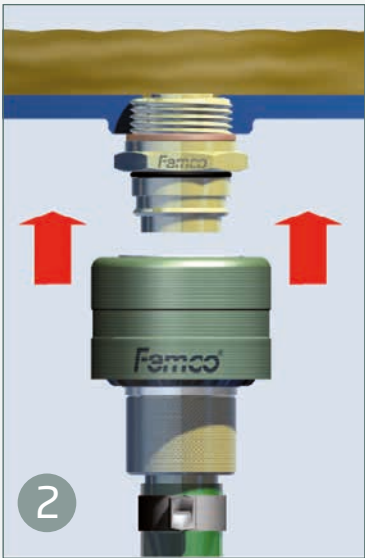
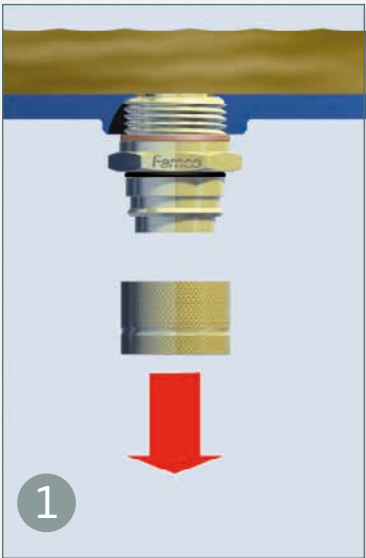

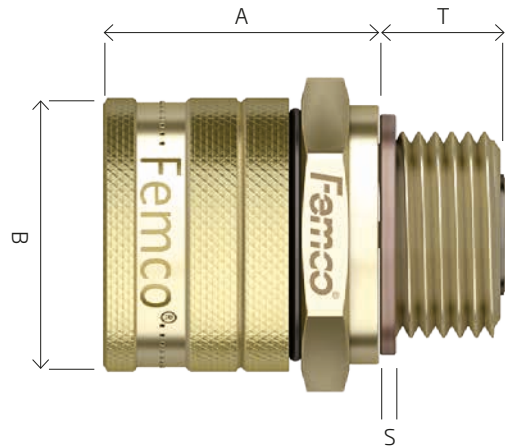
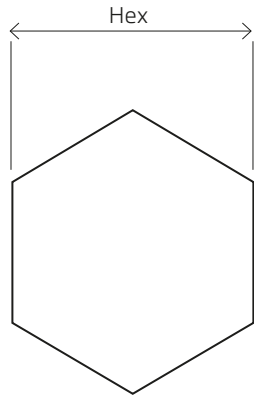

METR. SIZES						
Thread size	Item number	T	A	B	S	Hex
M12x1.25	8090020419	10	32	30	2	30
M12x1.5	8090020420	10	32	30	2	30
M12x1.75	8090020421	10	32	30	2	30
M14x1.25	8090020422	10	32	30	2	30
M14x1.5	8090020423	10	32	30	2	30
M16x1.5	8090020426	10	32	30	2	30
M18x1.5	8090020428	10	32	30	2	30
M18x1.5	8090020477	14	32	30	2	27
M20x1.5	8090020432	15	32	30	2	30
M20x1.5	8090020430	10	32	30	2	30
M22x1.5	8090020436	10	32	30	2	30
M22x1.5	8090020440	15	32	30	2	30
M24x1.5	8090020444	12	30	30	2	30
M24x1.5	8090020445	15	27	30	2	30
M24x2.0	8090020447	12	30	30	2	30
M25x1.5	8090020451	15	27	30	2	32
M26x1.5	8090020452	10	30	30	2	32
M26x1.5 50L	8090020455	10	45	30	2	32
M27x2.0	8090020458	12	32	30	2	32
M27x2.0 o-ring	8090020459	12	32	30	o-ring	32
M30x1.5	8090020463	10	30	30	2	36
M32x1.5	8090020467	12	30	30	2	36
M36x2.0	8090020471	12	30	30	2	42
M42x2.0	8090020469	12	30	30	2	50

NPT						
Thread size	Item number	T	A	B	S	Hex
3/8-18 NPT	8060020512	10	32	30	n/a	30
1/2 14 NPT	8060020513	12	32	30	n/a	30
3/4-14 NPT	8060020514	12	30	30	n/a	32
3/4-14 NPT	8060020520	15	30	30	n/a	32
1-11.5 NPT	8060020516	12	27	30	n/a	36

UNF						
Thread size	Item number	T	A	B	S	Hex
1/2-20 UNF	8080020477	10	32	30	2	30
1/2-20 UNF	8080020512	12	32	30	2	30
3/4-16 UNF	8080020481	10	30	30	2	30
3/4-16 UNF	8080020482	15	32	30	2	30
7/8-14 UNF	8080020483	10	32	30	2	30
7/8-18 UNF	8080020486	10	32	30	2	30
7/8-20 UNF	8080020487	10	32	30	2	30
1 1/2-12 UNF	8080020496	12	30	30	2	46
1 1/8-12 UNF	8080020498	12	32	30	2	36
1 5/16-12 UNF	8080020494	12	30	30	2	36
1-1/16-12 UNF	8080020490	15	27	30	2	32
1-1/8 12 UNF	8080020491	15	27	30	2	36
1-14 UNF	8080020489	12	32	30	2	32

BSP						
Thread size	Item number	T	A	B	S	Hex
3/8-19 BSP	8080020501	10	32	30	2	30
1/2-14 BSP	8080020502	10	32	30	2	30
1-11 BSP	8080020506	12	30	30	2	36

UNS						
Thread size	Item number	T	A	B	S	Hex
1-18 UNS	8060020519	12	30	30	2	32

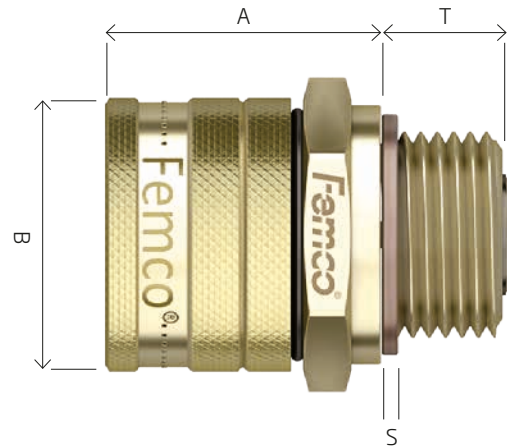
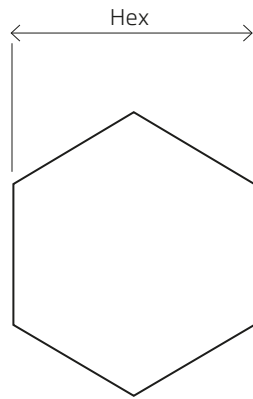

METR. SIZES						
Thread size	Item number	T	A	B	S	Hex
M12x1.25	8090010049	9	26	25	2	22
M12x1.5	8090010044	10	26	25	2	22
M12x1.75	8090010421	9	26	25	2	22
M14x1.25	8090010422	9	26	25	2	22
M14x1.5	8090010423	9	26	25	2	22
M16x1.5	8090010426	9	26	25	2	22
M18x1.5	8090010433	14	27	25	2	24
M20x1.5	8090010430	10	27	25	2	27
M22x1.5	8090010436	10	23	25	2	27
M22x1.5	8090010441	15	27	25	2	27

NPT						
Thread size	Item number	T	A	B	S	Hex
3/8-18 NPT	8060010512	9	27	25	n/a	22
1/2 14 NPT	8060010514	12	27	25	n/a	22

UNF						
Thread size	Item number	T	A	B	S	Hex
1/2-20 UNF	8080010477	9	26	25	2	22
1/2-20 UNF	8080010475	12	24	25	2	22
3/4 16 UNF	8080010481	10	27	25	2	27
3/4-16 UNF	8080010482	15	27	25	2	27

BSP						
Thread size	Item number	T	A	B	S	Hex
1/2-14 BSP	8080010502	10	27	25	2	27
3/8-19 BSP	8080010501	9	26	25	2	22

DOUBLE CLICKER FOR FEMCO® LB PLUG	ITEM NUMBER
Double Click drainer Straight	840001
Double Click drainer Straight 25cm Hose	840002
Double Click drainer Straight 130 cm hose	840003
Double Click drainer angled 90	840004
Double Click drainer angled 90, 25cm hose	840005
Double Click drainer angled 90, 130cm hose	840006
Double Click drainer angled 45	840007
Double Click drainer angled 45, 25cm hose	840008
Double Click drainer angled 45, 130cm hose	840009

SOLO CLICKER FOR FEMCO® LB PLUG	ITEM NUMBER
Solo Click drainer Straight	840010
Solo Click drainer Straight 25cm hose	840011
Solo Click drainer Straight 130 cm hose	840012
Solo Click drainer angled 90	840013
Solo Click drainer angled 90, 25cm hose	840014
Solo Click drainer angled 90, 25cm hose	840015
Solo Click drainer angled 45	840016
Solo Click drainer angled 45, 25cm hose	840017
Solo Click drainer angled 45, 130cm hose	840018



DOUBLE CLICKER FOR FEMCO® SB PLUG	ITEM NUMBER
Double Click drainer Straight	840019
Double Click drainer Straight 25cm hose	840020
Double Click drainer Straight 130 cm hose	840021
Double Click drainer angled 90	840022
Double Click drainer angled 90, 25cm hose	840023
Double Click drainer angled 90, 130cm hose	840024
Double Click drainer angled 45	840025
Double Click drainer angled 45, 25cm hose	840026
Double Click drainer angled 45, 130cm hose	840027

SOLO CLICKER FOR FEMCO® SB PLUG	ITEM NUMBER
Solo Click drainer Straight	840028
Solo Click drainer Straight 25cm Hose	840029
Solo Click drainer Straight 130 cm hose	840030
Solo Click drainer angled 90	840031
Solo Click drainer angled 90, 25cm hose	840032
Solo Click drainer angled 90, 25cm hose	840033
Solo Click drainer angled 45	840034
Solo Click drainer angled 45, 25cm hose	840035
Solo Click drainer angled 45, 130cm hose	840036



CLICK DESIGN

ACCESSOIRES

SIZES DOUBLE CLICKER	ITEM NUMBER		A	B	C	D
Double Clicker 3/4" BSP	851013	LB	49	37	12	3/4"BSP
Double Clicker 1/2" BSP	851017	LB	49	37	12	1/2"BSP
Double Clicker 1" BSP	851019	LB	49	37	12	1"BSP
Double Clicker 3/4" 14 NPT	851018	LB	49	37	12	3/4"NPT

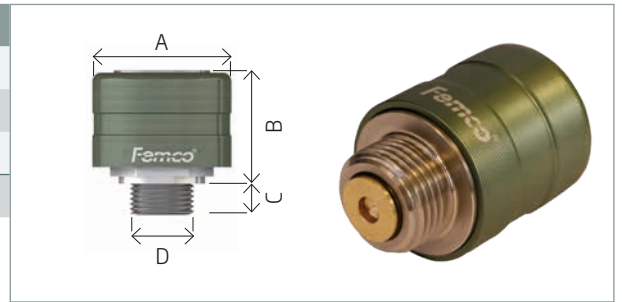

SIZES SOLO CLICKER	ITEM NUMBER		A	B	C	D
Solo Clicker 1/2" BSP	850102	SB	33	29	11	1/2"BSP
Solo Clicker 1/2" BSP	851000	LB	49	37	12	1/2"BSP

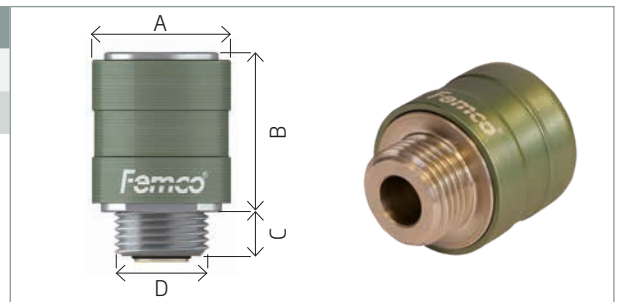

SOLO CLICKER HOSE CONNECTION	ITEM NUMBER		A	B	C	D
Solo clicker hose connection	850101	SB	33	29	20	15
Solo clicker hose connection, 25cm hose	850105	SB				
Solo clicker hose connection, 130cm hose	850106	SB				
Solo clicker hose connection	851015	LB	49	37	12	15
Solo clicker hose connection, 25cm hose	851026	LB				
Solo clicker hose connection, 130cm hose	851027	LB				

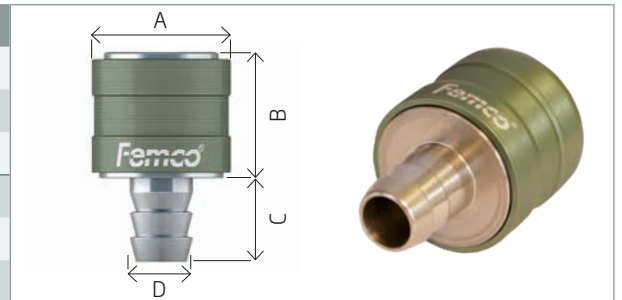

SIZES SOLO CLICKER	ITEM NUMBER	
Sealing Cap for Clicker	850109	LB



PRODUCTS

QUICK OIL DRAIN PLUG

The Quick Drain is a two-in-one solution which combines a plug with a drain connector. When it's time to perform an oil change, simply 'push and turn'.

You can simply use the oil drain valve without using any specialist tools. In addition to this it is easy to take oil samples using the Quick Drain. The Quick Drain oil drain valve also incorporates a locking system to ensure an effective seal.



HOW TO DRAIN YOUR OIL (OR OTHER FLUIDS)

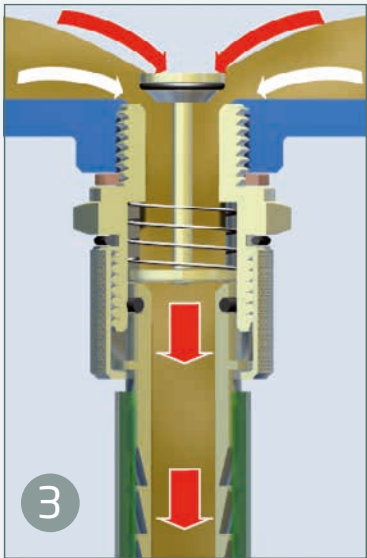
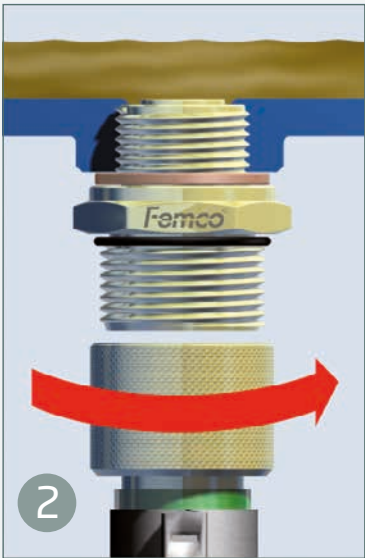
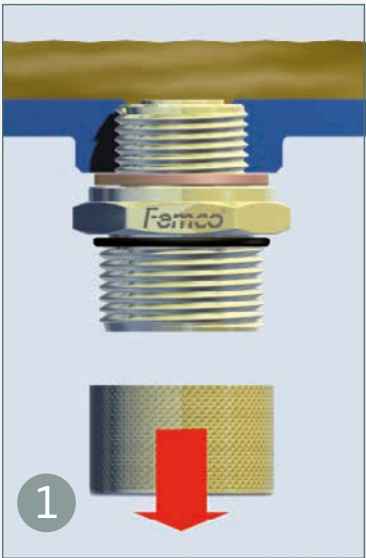

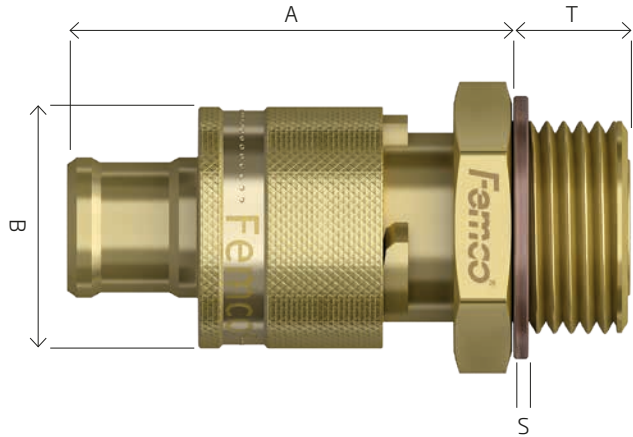
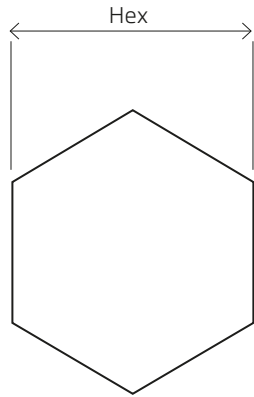

METR. SIZES						
Thread size	Item number	T	A	B	S	Hex
M12x1.25	6190010001	10	48	14	2	27
M12x1.75	6190010004	10	48	14	2	27
M12x1.5	6190010009	10	48	14	2	27
M14x1.25	6190010012	10	48	14	2	27
M14x1.5	6190010006	10	48	14	2	27
M16x1.5	6190010010	10	48	14	2	27
M18x1.5	6190010015	14	49	14	2	27
M20x1.5	6190010016	10	48	14	2	27
M22x1.5	6190010019	10	48	14	2	27
M22x1.5	6190010021	15	48	14	2	27
M27x2,0	6190010035	12	46	14	2	27

NPT						
Thread size	Item number	T	A	B	S	Hex
1/2-14-NPT	6160010002	12	46	14	n/a	27
3/8-18-NPT	6160010003	10	48	14	n/a	27

UNF						
Thread size	Item number	T	A	B	S	Hex
3/4-16-UNF	6180010007	10	48	14	2	27
3/4-16-UNF	6180010008	15	48	14	2	27
1/2-20-UNF	6180010001	10	48	14	2	27

BSP						
Thread size	Item number	T	A	B	S	Hex
1/2-14-BSP	6170010001	10	48	14	2	27
3/8-19-BSP	6170010008	10	48	14	2	27

PRODUCTS

XL OIL DRAIN PLUG

The XL is the biggest oil drain plug we produce and is the ideal solution for vehicles and machines with a large oil capacity. Our XL oil drain plug has an optimised flow and is specially designed to drain large volumes of oil in a short amount of time. Therefore, the XL is the ideal solution for heavy equipment such as trucks and mining equipment. To service fleets of large vehicles Femco® has also introduced the XL Click Drain. This quick-coupling system combines the advantages of the XL and the Click Drain plugs. Therefore, the XL Click Drain is the most effective solution for fleets of heavy equipment and train.



HOW TO DRAIN YOUR OIL (OR OTHER FLUIDS)

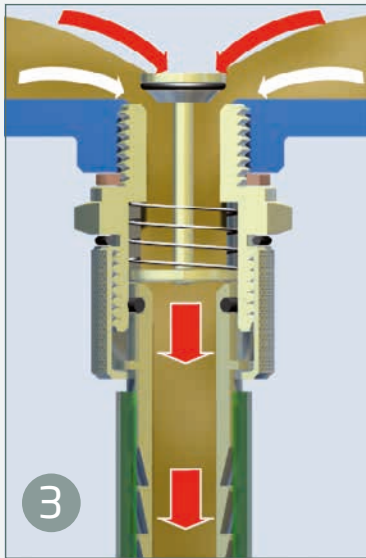
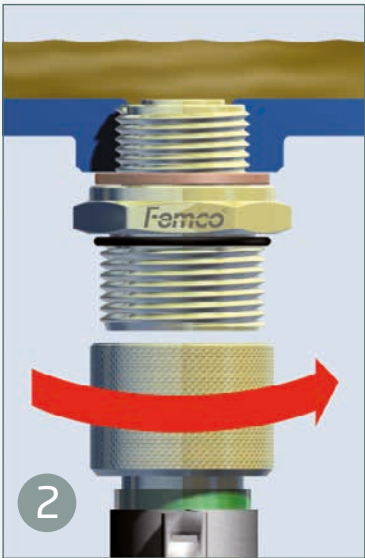
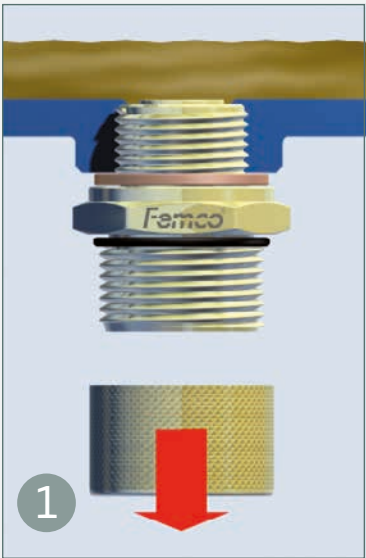

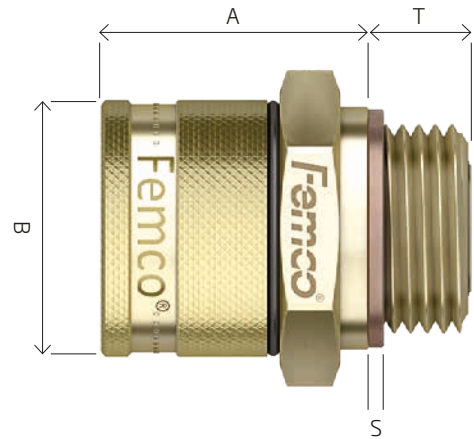
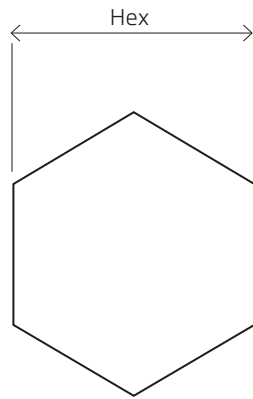

METR. SIZES						
Thread size	Item number	T	A	B	S	Hex
M27x2.0	5090020272	12	30	40	2	36
M27x2.0 o-ring	5090020273	12	30	40	o-ring	36
M30x1.5	5090020301	10	32	40	2	36
M32x1.5	5090020322	12	30	40	2	41

NPT						
Thread size	Item number	T	A	B	S	Hex
1 1/8 NPT	5060021115	12	30	40	n/a	41

UNF						
Thread size	Item number	T	A	B	S	Hex
1 1/16-12 UNF	5080021116	15	30	40	2	36
1 1/2-12 UNF	5080021120	12	30	40	2	46
1-1/8 12 UNF	5080021180	15	27	40	2	36
1 1/8-12 UNF	5080021181	12	27	40	2	36
1 5/16-12 UNF	5080021516	12	30	40	2	36

BSP						
Thread size	Item number	T	A	B	S	Hex
1-11 BSP	5070021111	12	30	40	2	41

DESCRIPTION	THREAD SIZE		ITEM NUMBER	A	B	C	D
Straight Drainer	M36 x 1.5	LB	655001	40	18	28	26
Straight Drainer with hose 25cm	M36 x 1.5	LB	655002				
Straight Drainer with hose 130cm	M36 x 1.5	LB	655003				

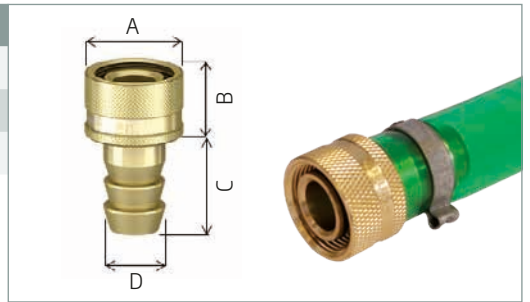

DESCRIPTION	THREAD SIZE		ITEM NUMBER	A	B	C	D	E
Angled drainer 90°	M36 x 1.5	LB	655006	40	18	48	43	26
Angled drainer 90° with hose 25cm	M36 x 1.5	LB	655007					
Angled drainer 90° with hose 130cm	M36 x 1.5	LB	655008					

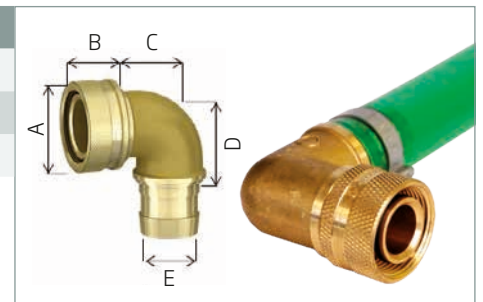

DESCRIPTION	THREAD SIZE		ITEM NUMBER	A	B	C
Angled drainer 45°	M36 x 1.5	LB	655009	40	52	26
Angled drainer 45° with hose 25cm	M36 x 1.5	LB	655010			
Angled drainer 45° with hose 40cm	M36 x 1.5	LB	655011			

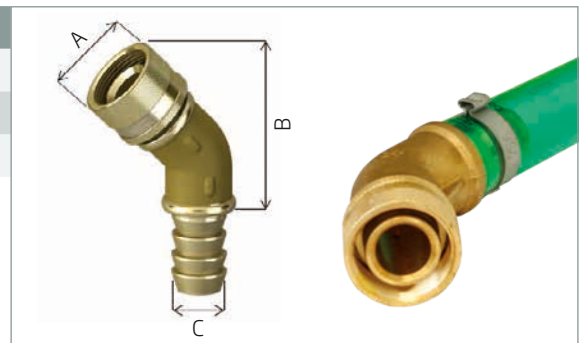

XL CLICK OIL DRAIN PLUG

The XL is the biggest oil drain plug we produce and is the ideal solution for vehicles and machines with a large oil capacity. Our XL oil drain plug has an optimised flow and is specially designed to drain large volumes of oil in a short amount of time. Therefore, the XL is the ideal solution for heavy equipment such as trucks and mining equipment. To service fleets of large vehicles Femco® has also introduced the XL Click Drain. This quick-coupling system combines the advantages of the XL and the Click Drain plugs. Therefore, the XL Click Drain is the most effective solution for fleets of heavy equipment and train.

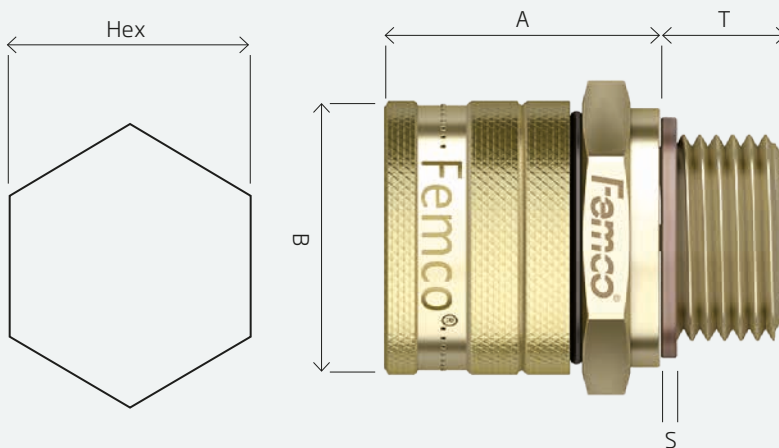

HOW TO DRAIN YOUR OIL (OR OTHER FLUIDS)

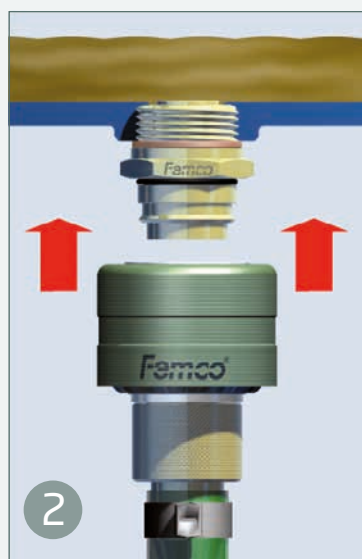
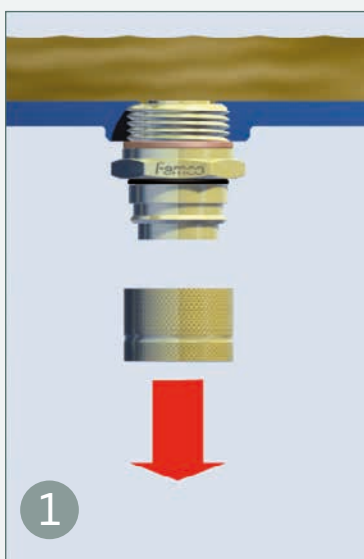

PRODUCT SPECIFICATIONS

XL CLICK DESIGN LB

METR. SIZES						
Thread size	Item number	T	A	B	S	Hex
M27x2.0	8190020272	12	30	40	2	41
M30x1.5	8190020301	10	30	40	2	41
M32x1.5	8190020322	12	30	40	2	41

NPT						
Thread size	Item number	T	A	B	S	Hex
1-11.5 NPT	8160021115	12	30	40	n/a	41

UNF						
Thread size	Item number	T	A	B	S	Hex
1-1/16-12 UNF	8180020492	12	30	40	2	41
1 ½-12 UNF	8180021120	12	30	40	2	41
1 1/8-12 UNF	8180021181	12	30	40	2	41
1 5/16-12 UNF	8180021516	12	30	40	2	41
1-1/8 12 UNF	8180020491	15	30	40	2	41

BSP						
Thread size	Item number	T	A	B	S	Hex
1-11 BSP	8170021111	12	30	40	2	41

ACCESSOIRES

XL CLICK DESIGN

DESCRIPTION	ITEM NUMBER	
XL Clicker 1 1/4 BSP	870100	
XL Clicker 1 BSP	870102	
XL Clicker M27	870103	
XL Clicker 1 11,5 NPT	850104	

DESCRIPTION	ITEM NUMBER	
Straight drainer	870107	

DESCRIPTION	ITEM NUMBER	
Sealing Cap for XL Clicker	870105	

DESCRIPTION	ITEM NUMBER	
Angled drainer 90°	870108	

DESCRIPTION	ITEM NUMBER	
Dust Cap XL Click	870106	





Femco Drainechnology B.V.

Rendementsweg 7

3641 SK Mijdrecht

The Netherlands

☎ +31 (0)297 - 23 02 05

✉ info@femco.com

Femco USA Inc.

15321 Main Street NE

Suite 319

Duvall WA 98019

United States

☎ +1 425 318 6050

✉ info@femco.com