



2023 / 2024

Original Equipment for the aftermarket

Spiegelsysteme für Nutzfahrzeuge
Mirror systems for commercial vehicles

I - II - III - IV - V - VI
Spiegelklasse
mirror class

Material des Spiegelgehäuses
material of the mirror body

Durchmesser der Spiegelstange
oder Art der Montage
diameter of the mirror bracket
or way of mounting

Fahrzeugtyp / Baujahr
vehicle model / year of production

EG-Prüf-Nummer
CE-number

Spiegeltyp
mirror type

Beschreibung des Artikels
description of the item

Abmessungen
dimensions

Originalnummer des Fahrzeugherstellers
OE number of the vehicle manufacturer

MEKRA Artikel-Nummer

grüner Hintergrund	Komplettsystem
grauer Hintergrund	Zubehör, im Lieferumfang des Komplettsystems
gelber Hintergrund	Zubehör, gesondert zu bestellen

MEKRA article number

green background	complete system
grey background	accessory, included in delivery of the complete system
yellow background	accessory, must be ordered separately

Part Number	Icons	Dimensions (mm)	OE Number
51.3921.224H	[Icons]	399 x 207 x 137	81.63730-6482
51.3923.224H	[Icons]	339 x 222 x 138	81.63730-6487
51.3921.223H	[Icons]	399 x 207 x 137	81.63730-6480
51.3923.223D	[Icons]	399 x 222 x 138	81.63730-6485
15.3920.840H	[Icons]	379 x 166 x 47	81.63733-6049
51.3922.224H	[Icons]	399 x 222 x 138	81.63730-6483
51.3924.224H	[Icons]	399 x 207 x 137	81.63730-6486
51.3922.223H	[Icons]	399 x 222 x 138	81.63730-6481
51.3924.223D	[Icons]		
51.3922.233H	[Icons]		
15.3920.840H	[Icons]		



Inhalt index

Aufbau der MEKRA Artikelnummern	
Structure of the MEKRA article numbers	04
Verzeichnis der Spiegel-Typen	
Mirror type list	05
Liste aller MEKRA Artikel im Katalog	
List of all MEKRA-articles in this catalogue	06-07
Homologationsnummernliste	
List of homologation numbers	08-09
Vergleichsliste nach OE - Nummern	
Cross-reference-table	10-17
Fahrzeughersteller	
Manufacturer	18-79
DAF	18-22
FORD	23
IVECO	24-25
MAN	26-41
MERCEDES	42-55
RENAULT	56-58
SCANIA	59
VOLVO	60-63
VOLKSWAGEN (VW)	63-65
UNIVERSAL	66-79
Allgemeine Verkaufs- und Lieferbedingungen	
General terms and conditions of sale and delivery	80-81

9 stellig digit

04...	
08...	
09...	
10...	
11...	
13...	
14...	
15...	
20...	
39...	
40...	
51...	
53...	
55...	
56...	
58...	
59...	
61...	

3. - 5. Ziffer digit = Spiegeltyp mirror type

12 stellig digit

08...	
09...	
11...	
12...	
14...	
15...	
19...	
20...	
40...	
51...	
55...	
56...	
58...	
59...	
61...	

3. - 6. Ziffer digit = Spiegeltyp mirror type

z. B. / e. g. 59.5800.101H = Typ / type 580

59.2910.001.001 = Typ / type 291

59.1018.003.099 = Typ / type 1018



152 ASKB	68
224	62
248/2 A	77
249 K	51
249 L	51
250	60
251	28
252	60
253	42
254	42
260	26
265	27
266	27
266-1	27
270 A	79
271	38,73
271 A	77
276	38
277	40
278	39
279	25
281	50
289	68
291	74,75
300	67
320	26
340	26
341	26
348	19,19,58,58
349	51,63
349 TW	51,63
360	60
360-1	60
363	23,68
364	28
365-1	27
370	60
371	60
373	18,30
375	43
375 A	43
377	43,46



377-1	43,46
378	46
378 A	46
378-1	46
380-1	31
381-1	31
385	66
386	18,30
386-1	18
389	67
390	22,56,57,61
392	32
392-1	33
392-2	34
393	32
393-1	33
393-2	34
395	50
396	45,47
398	50
400	59
552	21
552-1	21,57,61,66,67
558	22,58,59,61
559	21,23
570	20
570 A	20
571	20
572	29,62
573	29,62
574	20
575	44
575 A	44
577	44
579	29,32,34,35,45,47
580	35
589	52,53,64,65
600	48
750	67
906	18,23
1000	63
1004	45,47,48



1005	21,23,59
1008	24,24,25
1009	69
1010	70
1012	48
1013	37,65
1016	78
1017	70
1017+1009	70
1018	72
1019	59
1020	37
1024	36
1025	21,58,62
1027	22
1036	71
1039	54,55
1041	41
1042	41
1043/1044	63



04.0603.004	32,33,34
08.1039.001.099	54
08.1039.002.099	54
08.1039.005.099	54
08.1039.006.099	54
08.1039.011.099	54
08.2770.001.000	40
08.2910.001.002	40,75
08.3200.233H	39,40,72,75,76
08.3950.001.099	40,75
08.5380.004.000	62
08.5752.012	39
08.5752.024.099	22,39,40,56
	57,61
08.5890.024.099	41
08.5890.300.099	53,65
08.5890.301.099	53,65
08.5892.001.099	53,65
08.5892.002.099	53,55,65
08.5892.003.099	53,55,65
08.5892.004.099	53,65
08.5892.105.099	53,55,65
09.1000.200.099	63
09.1041.002.099	41
09.1041.004.099	41
09.2000.301H	26,27,66,69,76
09.2070.101H	26,28,42,60,68
	76
09.2770.001.000	40,75
09.2770.210	40
09.2770.211 +	
09.2770.210	40
09.2910.002.099	72,75
09.2910.003.099	40,75
09.2910.004.099	75
09.2910.005.099	72,75
09.2910.007.000	75
09.3200.220	76
09.3200.320H	76
09.3200.320H	76
09.3200.420H	26,69,71
09.3200.420H	76
09.3300.421	76
09.3400.420	26,66,76
09.3900.003.000	22,56,57,61
09.5700.001.099	20
09.5700.002.099	20
09.5750.001.099	44
09.5750.220.099	44
10.6111.100	28
10.6121.100	26,28
10.6211.100	28,66
10.6211.140	42
10.6221.100	28,66,68
10.6321.100	26,27
11.1008.001.099	24
11.1036.011.099	71
11.1036.012.099	71
11.1036.013.099	71
11.1036.014.099	71
11.1039.001.099	54
11.1039.002.099	54
11.1039.011.099	54
11.1039.012.099	54
11.2770.102	40
11.2770.202	40
11.2770.302	40
11.2770.402	40
11.2770.920	40
11.2780.910	39
11.2780.920	39
11.2790.001.099	25
11.2790.002.099	25
11.2810.200H	50
11.2910.001.000	75
11.2910.002.000	75
11.2910.003.000	75
11.2910.004.000	75
11.2910.006.000	75
11.2910.007.000	75
11.2910.008.000	75
11.2910.009.000	75
11.2910.011.002	75
11.2910.012.002	75
11.3480.100	19,58
11.3730.210H	18,23,38,68,73
11.3730.310H	30
11.3800.300H	31
11.3810.340	31
11.3860.300H	30
11.3860.500H	18
11.3860.700	29,30,31
11.3900.100H	57
11.3900.101H	57
11.3900.200H	22,56,61
11.3900.201H	56



11.3910.110H	57
11.3910.111H	57
11.3910.120H	57
11.3910.121H	57
11.3910.200H	22,56,61
11.3910.201H	56
11.3920.300H	32
11.3921.110H	32,33
11.3921.120H	32,33
11.3921.400	33,34
11.3931.110H	32,33
11.3931.120H	32,33
11.5700.100H	20
11.5710.110H	20
11.5721.001.099	29,62
11.5731.001.099	29,62
11.5800.100H	35
11.5800.200H	35
11.9060.100H	18,23
12.1005.001.099	23
12.1018.001.099	72
12.1018.002.099	72
12.1018.003.099	72
12.1018.005.099	72
12.1018.007.099	72
12.1018.009.001	72
12.1018.010.001	72
12.1020.003.099	37
12.1024.009.099	36
12.1024.010.099	36
12.1024.011.099	36
12.1024.012.099	36
12.1027.001.099	22
12.1027.002.099	22
12.1027.005.099	22
12.1027.006.099	22
12.1027.015.099	22
12.1027.016.099	22
12.1027.103.099	22
12.1027.104.099	22
12.1027.107.099	22
12.1027.108.099	22
12.1027.203.099	22
12.1027.204.099	22
12.1027.207.099	22
12.1027.208.099	22
12.1041.001.099	41
12.1041.002.099	41
12.1041.003.099	41
12.1041.004.099	41
12.1041.005.099	41
12.1042.001.099	41
12.1042.002.099	41
12.3920.001.099	34
12.3920.002.099	34
12.3930.001.099	34
12.3930.002.099	34
12.5590.009.099	23
12.5740.002.099	20
13.1024.001.099	36
13.1024.002.099	36
13.1024.003.099	36
13.1024.004.099	36
13.1039.001.099	54
13.1039.002.099	54
13.1043.001.000	63
13.1044.001.000	63
13.5800.100H	35
13.5890.110.199	53,55,65
13.5890.120.099	53,55,65
13.5890.210.199	53,55,65
13.5890.220.099	53,55,65
14.5890.100.099	53,55,65
14.5890.200.099	53,55,65
15.2240.840H	62
15.2711.114	38,73
15.2711.214H	51,63
15.2712.113F	73
15.2712.114	38,73
15.2771.840	40
15.2771.870	40
15.2780.840	39,41,75
15.2780.841F	39,72,75
15.2780.870	39
15.2780.871F	39
15.2810.480H	50
15.3480.840H	19,58
15.3491.071H	51,63
15.3491.072H	51,63
15.3491.371H	51,63
15.3491.372H	51,63
15.3702.470H	60
15.3731.070H	30
15.3731.074H	30
15.3731.470H	18,38,73



15.3752.470H	43,50
15.3771.174H	43,46,50
15.3774.410H	43,46
15.3780.840H	46
15.3784.470H	46
15.3802.840H	23,31,68
15.3811.870H	31
15.3861.114H	18
15.3862.174H	18
15.3900.840H	22,56,57,61
15.3910.871H	57
15.3910.872H	57
15.3911.871H	22,56,61
15.3911.872H	22,56,61
15.3920.840H	33
15.3921.870H	32
15.3922.870H	32
15.3931.870H	32
15.3932.870H	33
15.3946.670F	27
15.3951.114	50
15.3951.174	50
15.3952.174	50
15.3961.174H	45,47
15.4001.740H	59
15.4001.840H	59
15.5701.840H	20
15.5711.870H	20
15.5750.840H	44
15.5770.870H	44
15.5791.470H	29,32,45,47
15.5791.570.099	29,32,34,35
15.5801.840H	35
15.5811.871H	35
15.5811.872H	35
15.5891.611H	53,65
15.5891.612H	53,65
15.5891.721.099	53,55,65
15.5891.722.099	53,55,65
15.5891.741H	53,65
15.5891.742H	53,65
15.6000.001.099	48
15.6000.002.099	48
15.6000.003.099	48
15.6000.004.099	48
15.9060.870H	18,23
19.1000.101.099	63
19.1000.102.099	63
19.1000.103.099	63
19.1008.041.099	24
19.1008.311.099	24
19.1012.000.099	48
19.1012.001.099	48
19.1012.002.099	48
19.1012.003.099	48
19.1013.011.099	37,65
19.1013.012.099	37,65
19.1018.311.099	72
19.1018.312.099	72
19.1019.013.099	59
19.1019.014.099	59
19.1019.313.099	59
19.1019.314.099	59
19.1020.213.099	37
19.1020.613.099	37
19.1024.011.099	36
19.1024.012.099	36
19.1024.311.099	36
19.1024.312.099	36
19.1036.005.099	71
19.1027.011.099	22
19.1027.012.099	22
19.1027.311.099	22
19.1027.312.099	22
19.1036.006.099	71
19.1036.007.099	71
19.1036.008.099	71
19.1036.009.099	71
19.1036.010.099	71
19.1039.011.099	54
19.1039.012.099	54
19.1039.311.099	54
19.1039.312.099	54
19.1039.411.099	54
19.1039.412.099	54
19.1039.812.099	54
19.1043.001.099	63
19.1044.001.099	63
19.2790.011.099	25
19.2790.012.099	25
19.2790.031.099	25
19.2790.032.099	25
19.2910.001.099	41,75
19.2910.002.099	41,75



19.3920.011.099	34
19.3930.311.099	34
19.5740.311.099	20
19.5750.011.099	44
19.5770.311.099	44
19.5890.011.099	53,55,65
19.5890.012.099	53,55,65
19.5891.011.099	53,65
19.5891.012.099	53,65
20.1016.004.000	78
20.1042.002.099	41
20.1042.003.099	41
20.2480.210H	77
20.2480.211H	77
20.2480.213	73,77
20.2480.216H	38,50,73,77
20.2480.217H	38,50,73,77
20.2480.223	77
20.2700.200H	38,73
20.2710.111H	73
20.2710.121	73
20.2710.200H	38,73
20.2710.620	38,39,77
20.2710.650	39
20.3750.710.099	43
20.3750.720.099	43
20.3780.700H	46
20.3900.510H	22,56,57,61
20.3900.520H	22,56,57,61
20.5521.100H	21
20.5700.410H	20
20.5700.420H	20
20.5750.710.099	44
20.5750.720.099	44
20.5800.410H	35
20.5800.420H	35
20.5800.610H	35
20.5800.620H	35
20.5800.710H	35
20.5800.720H	35
20.5800.750H	35
20.7504.003.001	67
20.7504.044.001	67
40.1009.001.000	69
40.1009.001.099	69
40.1009.002.000	69
40.1009.002.099	69
40.1009.003.099	69
40.1009.004.099	69
40.1009.005.099	69
40.1009.401.000	69
40.1009.402.000	69
40.1010.002.099	70
40.1525.114H	68
40.2500.222H	60
40.2500.422H	60
40.2510.222H	28
40.2510.322H	28
40.2510.422H	28
40.2520.222H	60
40.2520.422H	60
40.2530.222H	42
40.2530.422H	42
40.2540.222H	42
40.2540.422H	42
40.2605.204H	26
40.2660.404H	27
40.2665.203H	27
40.2665.204H	27
40.2665.403H	27
40.2890.222H	66,68
40.2890.322	66
40.2890.422H	66,68
40.3200.422H	26
40.3485.403H	19,58
40.3485.412H	19,58
40.3605.203H	60
40.3605.204F	60
40.3605.403H	60
40.3640.222H	26,28
40.3640.322H	28
40.3640.422H	26,28
40.5725.212H	29
40.5725.412H	29,62
40.5735.203H	29
40.5735.403H	29,62
51.1009.001.099	69
51.1009.009.099	69
51.1009.017.099	69
51.1009.021.099	69
51.1009.022.099	69



51.3920.003.099	34	56.3492.110H	51,63	59.1018.001.099	72	59.2910.008.001	74	59.1039.254.099	54
51.3920.004.099	34	56.3811.168H	31	59.1018.002.099	72	59.2910.009.001	74	59.1039.258.099	54
51.3920.005.099	34	56.3812.128H	31	59.1018.003.099	72	59.2910.010.001	74	59.1039.275.099	54
51.3920.012.099	34	56.3812.148H	31	59.1018.004.099	72	59.2910.012.001	74	61.1009.001.099	69
51.3920.013.099	34	56.3812.168H	31	59.1018.007.099	72	59.2910.013.001	74	61.1009.002.099	69
51.3920.014.099	34	56.3860.112H	30	59.1018.008.099	72	59.2910.014.001	74	61.1029.224.099	22
51.3921.222H	32	56.3860.114H	30	59.1024.001.099	36	59.2910.015.001	74	61.1024.224.099	22
51.3921.223H	33	56.3861.116H	30	59.1024.002.099	36	59.2910.016.001	74	61.1039.002.099	54
51.3921.224H	33	56.3862.116H	30	59.1024.005.099	36	59.2910.017.001	74	61.1042.005.099	41
51.3922.222H	32	56.3930.001.099	34	59.1024.006.099	36	59.2910.018.001	74	61.1042.006.099	41
51.3922.223H	33	56.3930.002.099	34	59.1024.009.099	36	59.2910.019.001	74	61.2530.110H	42
51.3922.224H	33	56.3930.003.099	34	59.1024.010.099	36	59.2910.020.001	74	61.2703.110	79
51.3923.222H	32	56.3930.004.099	34	59.1024.013.099	36	59.3491.110H	51	61.2703.120	79
51.3923.223D	33	56.3931.222H	32	59.1024.014.099	36	59.3491.120H	51	61.2708.842H	79
51.3923.224H	33	56.3931.323H	33	59.1024.017.099	36	59.3492.110H	51	61.2770.210	40
51.3924.223D	33	56.3931.343H	33	59.1024.019.099	36	59.3492.120H	51	61.2770.211	40
51.3924.224H	33	56.3932.222H	32	59.1024.021.099	36	59.3601.128H	60	61.2770.900.099	40
51.5524.930H	22,57,61,67	56.3932.323H	33	59.1024.022.099	36	59.3601.178H	60	61.2770.901.099	40
51.5720.120H	29	56.3932.343H	33	59.1024.023.099	36	59.3601.188H	60	61.2772.100	40
51.5720.140H	29	56.3960.148H	45,47	59.1024.024.099	36	59.3602.128H	60	61.2772.211.099	40
51.5721.160H	29	56.5730.120H	29	59.1024.025.099	36	59.3652.128H	27	61.2910.001.001	75
51.5722.160H	29	56.5730.140H	29	59.1024.026.099	36	59.3652.148H	27	61.2910.002.001	75
51.5750.001.099	44	56.5790.002.099	34,35	59.1024.027.099	36	59.3652.168H	27	61.2910.003.001	75
51.5750.002.099	44	56.5790.003.099	29,32	59.1024.028.099	36	59.3891.140H	67	61.2910.004.001	75
51.5750.003.099	44	56.5790.004.099	29,32,45,47	59.1024.029.099	36	59.3900.123H	57	61.2910.005.001	75
51.5750.004.099	44	56.9065.110	18,23	59.1024.030.099	36	59.3900.133H	22,56,61	61.2910.006.001	75
51.5770.001.099	44	58.1016.001.099	78	59.1025.001.099	21,58,62	59.3900.143H	22,56,61	61.2910.007.001	75
51.5891.111.199	52,64	58.1016.002.099	78	59.1025.002.099	21,58,62	59.3900.223H	57	61.2910.008.001	75
51.5891.112.199	52,64	58.1016.003.099	78	59.1027.001.099	22	59.3900.233H	22,56,61	61.2910.021.001	75
51.5891.113.199	52,64	58.1016.004.099	78	59.1027.002.099	22	59.3900.243H	22,56,61	61.2910.022.001	75
51.5891.114.199	52,64	58.1016.005.099	78	59.1027.003.099	22	59.3900.323H	57	61.3000.001.001	67
51.5891.211.199	52,64	58.1016.006.099	78	59.1027.004.099	22	59.3900.333H	22,56,61	61.3000.002.001	67
51.5891.212.199	52,64	58.1017.005.099	70	59.1039.101.099	54	59.3900.343H	22,56,61	61.3480.149H	19,58
51.5891.213.199	52,64	58.1017.006.099	70	59.1039.104.099	54	59.3900.323H	57	61.3481.149H	19,58
51.5891.214.199	52,64	58.1017.011.099	70	59.1039.105.099	54	59.3900.433H	22,56,61	61.3482.149H	19,58
51.5891.311.199	52,64	58.1017.012.099	70	59.1039.125.099	54	59.3900.443H	22,56,61	61.3730.324H	18
51.5891.312.199	52,64	58.1017.013.099	70	59.1039.155.099	54	59.3901.123H	57	61.3730.326H	18
51.5891.313.199	52,64	58.1017.014.099	70	59.1039.201.099	54	59.3901.133H	56	61.3752.147H	43,50
51.5891.314.199	52,64	58.1017.015.099	70	59.1039.204.099	54	59.3901.143H	56	61.3752.167H	43,50
51.5891.411.199	52,64	58.1017.016.099	70	59.1039.205.099	54	59.3901.223H	57	61.3772.147H	43,46
51.5891.412.199	52,64	58.2704.044	79	59.1039.225.099	54	59.3901.233H	56	61.3772.147H	43,46
51.5891.413.199	52,64	58.2704.048	79	59.1039.255.099	54	59.3962.210H	45	61.3773.147H	43,46,50
51.5891.414.199	52,64	58.2704.051H	79	59.1039.501.099	55	59.3964.210H	45	61.3780.100H	18,23
51.5892.111.199	52,64	58.2704.070	79	59.1039.525.099	55	59.3965.210H	47	61.3780.147H	46
51.5892.112.199	52,64	58.2704.086	79	59.1039.551.099	55	59.3980.011H	50	61.3782.147H	46
51.5892.113.199	52,64	58.2704.088	79	59.1039.558.099	55	59.3980.012	50	61.3782.167H	46
51.5892.211.199	52,64	58.2704.093	79	59.1039.575.099	55	59.3980.021H	50	61.3783.147H	46
51.5892.212.199	52,64	58.2705.001H	79	59.1039.601.099	55	59.3980.022H	50	61.3783.167H	46
51.5892.213.199	52,64	58.2705.003	79	59.1039.625.099	55	59.3980.111	50	61.3860.100	18,23
51.5892.311.199	52,64	58.3752.100	43	59.1039.651.099	55	59.3980.112	50	61.3860.214H	18
51.5892.312.199	52,64	58.3752.200	43	59.1039.658.099	55	59.3980.121	50	61.3865.124H	18
51.5892.313.199	52,64	58.3781.100H	46	59.1039.675.099	55	59.3980.122	50	61.3900.100H	22,56,57,61
51.5892.411.199	52,64	58.3781.200H	46	59.1039.701.099	55	59.3980.132	50	61.3900.110H	22,56,57,61
51.5892.413.199	52,64	58.3783.200H	46	59.1039.751.099	55	59.3980.141	50	61.3900.120H	22,56,57,61
51.5893.111.199	52,64	58.3783.300H	46	59.1039.801.099	55	59.3980.142	50	61.3900.130H	22,56,57,61
51.5893.112.199	52,64	58.5700.003.002	20	59.1039.851.099	55	59.5520.130H	21	61.3910.110H	57
51.5893.113.199	52,64	58.5700.004.002	20	59.1041.001.099	41	59.5520.230H	21	61.3910.120H	57
51.5893.211.199	52,64	58.5700.001.099	20	59.1041.002.099	41	59.5520.240H	21	61.3911.110H	22,56,61
51.5893.212.199	52,64	58.5701.104.099	20	59.1042.001.099	41	59.5520.530H	66	61.3911.120H	22,56,61
51.5893.213.199	52,64	58.5710.001.099	20	59.1042.002.099	41	59.5524.530H	67	61.5590.001.099	21,75
51.5894.112.199	52,64	58.5713.114.099	20	59.1042.003.099	41	59.5524.648.099	22,57,61	61.5700.210H	20
51.5894.212.199	52,64	58.5750.005.199	44	59.1042.004.099	41	59.5524.649.099	57	61.5700.310.099	20
51.5894.310.199	52,64	58.5750.012.199	44	59.1042.005.099	41	59.5580.147H	22,58	61.5710.210H	20
51.5894.410.199	52,64	58.5752.100H	44	59.2652.110H	27	59.5580.247H	22,58,61	61.5710.310.099	20
51.5895.312.199	52,64	58.5752.200H	44	59.2710.401H	73	59.5581.100H	59	61.5721.004.099	29,62
51.5895.412.001	52,64	58.5752.300H	44	59.2710.402H	73	59.5590.013.099	23	61.5721.005.099	62
55.1008.001.099	25	58.5752.400E	44	59.2710.406	73	59.5590.014.099	23	61.5721.006.099	62
55.1008.002.099	25	58.5800.101H	35	59.2710.454	73	59.5595.131H	21	61.5731.001.099	62
55.1008.003.099	25	58.5800.102H	35	59.2712.111	38	59.5595.132H	21	61.5740.001.099	20
55.1008.003.099	25	58.5800.201H	35	59.2712.114	38	59.5595.134	21	61.5750.100H	44
55.1008.004.099	25	58.5800.202H	35	59.2762.101	38	59.5595.135	21	61.9065.114H	18,23
55.3000.001.001	67	59.1005.001.099	21	59.2762.322	38	59.5595.136	21		
55.3000.002.001	67	59.1005.002.099	21	59.2762.422	38	59.5595.235H	21		
55.3000.003.001	67	59.1005.003.099	59	59.2770.210.099	40	59.5595.236	21		
55.3000.004.001	67	59.1005.011.099	23	59.2770.211.099	40	59.5595.331H	21		
56.1004.001.099	45,47,48	59.1008.005.099	24	59.2771.210	40	59.5595.332	21		
56.1008.001.099	24	59.1008.006.099	24	59.2780.120.099	39	59.5800.101H	35		
56.1008.002.099	24	59.1008.011.099	24	59.2780.130	39	59.5800.102H	35		
56.1008.003.099	24	59.1008.012.099	24	59.2780.140.001	39	59.5800.121H	35		
56.1008.004.099	24	59.1008.017.099	24	59.2780.150.001	39	59.5800.122H	35		
56.1020.015.099	37	59.1008.018.099	24	59.2780.160.001	39	59.5800.201H	35		
56.1020.017.099	37	59.1008.045H	24	59.2780.170.001	39	59.5800.202H	35		
56.1020.018.099	37	59.1008.046H	24	59.2780.180.001	39	59.5800.203H	35		
56.1020.019.099	37	59.1008.051H	24	59.2780.200.001	39	59.5800.221H	35		
56.1020.020.099	37	59.1008.052H	24	59.2780.230	39	59.5800.222H	35		
56.2600.127H	26	59.1008.057H	24	59.2781.120	39	59.5800.223H	35		
56.2600.147H	26	59.1008.058H	24	59.2810.111H	50	59.5800.302H	35		
56.2650.121H	27	59.1017.003.099	70	59.2810.113H	50	59.5800.322H	35		
56.2660.001.099	27	59.1017.004.099	70	59.2910.001.001	74	59.5800.402H	35		
56.2660.002.099	27	59.1017.005.							

Homologationsnummern – List of homologation numbers

e	E	Typ • type tipo • тип	Typ • type tipo • тип	
II	e1	03*0002	575	44
IV	e1	03*0003	577	44
IV	e5	02*0003	156/6 BO	--
IV	e11	03*0003	224	62
IV	e11	02*0003	224	62
V	e5	02*0004	156/6 BO	--
V	e11	03*0004	224	62
VI	e11	03*0005	224	62
VI	e11	02*0005	224	62
IIIII	e1	03*0006	589	52,53,64,65
III	e1	03*0007	570	20
IV	e1	03*0008	571	20
II	e1	03*0009	390	22,56,57,61
IV	e1	03*0010	390	22,56,57,61
V	e1	03*0011	558	22,58,59,61
V	e1	02*0013	379-1	--
IV	e1	03*0014	906	18,23
VVI	e1	03*0015	365-1	27
			394, 394-1	--
VI	e1	03*0016	389	67
VI	e1	03*0017	396	45,47
II	e1	03*0018	378-1	46
IV	e1	02*0019	377-1	43,46
II	e1	03*0022	271	38,73
			271-K	--
			276	38
			363	23,68
			373	18,30
			380-1	31
IV	e1	03*0023	386, 386-1	--
			381-1	31
II	e1	03*0024	392-1	33
II	e1	03*0024	392-2	34
IV	e1	03*0025	393-1	33
IV	e1	03*0025	393-2	34
II	e1	03*0031	572	29,62
IV	e1	03*0032	573	29,62
V+VI	e1	03*0033	552-1	21,57,61,66,67
IV	e1	03*0037	390	22,56,57,61
V	e1	02*0039	360-1	60
VI	e1	03*0042	287-1 / 288-1	--
V	e1	03*0044	287-1 / 288-1	--
II	e1	03*0047	273	--
			395	50
II	e1	03*0048	340	26
II	e11	03*0050	400	59
II	E11	02*0050	400	59
IV	e11	03*0051	400	59
IV	E11	02*0051	400	59
II	e1	03*0060	364-1	--
II	E1	01*00620	273	--
			395	50
II	e1	03*0082	274	--
II	e1	03*0084	277	40
II	e1	03*0088	271	38,73
			271-K	--
			276	38
			363	23,68
			373	18,30
			380-1	31
II	e1	03*0097	580	35
IV	e1	03*0098	580	35
V	e1	03*0109	579	29,32,34,35,45,47
II	e1	03*0115	380-1	31
II	e1	03*0123	375	43
			398	50
II	e1	03*0124	281	50
II	e1	03*0128	278	39
IV	e1	03*0129	278	39
V	e1	03*0174	395	50
II	e1	03*0184	348	19,19,58,58
V	e1	03*0185	348	19,19,58,58
II	e1	03*0188	374-1	--
IV	E5	01*019	156/6 BO	--
VI	e1	03*0196	559	21
V	E5	01*020	156/6 BO	--
IV	e1	03*0234	371-1	--
II	e1	03*0242	1000-1	--
IV	e1	03*0243	1000-2	--
V	e1	03*0244	1001	--
VI	e1	03*0245	1002	--
II	e1	03*0257	385-1	--
II	E1	01*0376	258	--
II	E1	01*0377	258	--
II	e1	02*0382	385	66
II	e1	02*0384	349	51,63
II	E1	01*0384	349	51,63
II	e1	01*0391	282	--
II	e1	01*0392	283	--
IV	E1	01*0392	283	--
IV	E1	01*0394	367	--
IV	E1	01*0394	367	--
IV	E1	01*0395	368	--
II	e1	02*0418	349	51,63
II	e1	01*0423	271	38,73
			271-K	--
			276	38
			363	23,68
			373	18,30
			380-1	31
			380-1	31
II	E1	01*0423	271	38,73
			271-K	--
			276	38
			363	23,68
			373	18,30
			380-1	31
IV	e1	02*0424	386, 386-1	--
			381, 386-1	--
IV	E1	01*0424	386, 386-1	--
			381	--
II	e1	02*0447	281	50
II	E1	01*0447	281	50
IV	e1	02*0448	281	50
II	E1	01*0448	281	50
IV	e1	02*0462	377	43,46
IV	E1	01*0462	377	43,46
II	e1	02*0463	378	46
II	E1	01*0463	378	46
V	e1	02*0464	379	--
V	E1	01*0464	379	--
II	e1	01*0469	385	66
II	E1	01*0469	385	66
II	e1	02*0487	372	--
IV	e1	02*0488	372	--
II	e1	02*0505	375	43
			398	50
II	E1	01*0505	375	43
			398	50
II	e1	02*0524	271	38,73
			271-K	--
			276	38
			363	23,68
			373	18,30
			380-1	31
II	E1	01*0524	271	38,73
			271-K	--
			276	38
			363	23,68
			373	18,30
			380-1	31
II	e1	02*0529	380-1	31
III	e1	02*0569	198	--
III	E1	01*0569	198	--
II	e1	02*0620	273	--
			395	50
II	e1	02*0646	392	32
II	E1	01*0646	392	32
IV	e1	02*0647	393	32
V	e1	02*0647	284	--
IV	E1	01*0647	393	32
II	e1	02*0662	374 (LDV)	--
II	e1	02*0688	405	--
IV	e1	02*0689	406	--
II	e1	02*0740	550	--
IV	e1	02*0741	551	--
V	e1	02*0742	552	21
V	E1	01*0742	552	21
II	e1	01*0798	901 (Iveco)	--
VVI	E1	02*0894	552-1	21,57,61,66,67
IIIII	E1	02*0902	589	52,53,64,65
II	E1	02*0905	271	38,73
			271-K	--
			276	38
			363	23,68
			373	18,30
			380-1	31
IV	E1	02*0906	906	18,23
II	E1	02*0910	274	--
V	E1	02*0912	558	22,58,59,61
IV	E1	02*0913	390	22,56,57,61
II	E1	02*0914	390	22,56,57,61
II	E1	02*0915	227	--
IV	E1	02*0916	390	22,56,57,61
IV	E1	02*0917	573	29,62
II	E1	02*0918	572	29,62
VVI	E1	02*0922	365-1	27
			394, 394-1	--
II	E1	02*0923	271	38,73
			271-K	--
			276	38
			363	23,68
			373	18,30
			380-1	31
IV	E1	02*0924	393-1	33
IV	E1	02*0924	393-2	34
II	E1	02*0925	392-1	33
II	E1	02*0925	392-2	34
II	E1	02*0926	273	--
			395	50
II	E1	02*0929	580	35
IV	E1	02*0930	580	35
VI	E1	02*0937	389	67
II	E1	02*0939	380-1	31
			276	38
			363	23,68
			373	18,30
			380-1	31
IV	E1	02*0924	393-1	33
IV	E1	02*0924	393-2	34
II	E1	02*0925	392-1	33
II	E1	02*0925	392-2	34
II	E1	02*0926	273	--
			395	50
II	E1	02*0929	580	35
IV	E1	02*0930	580	35
VI	E1	02*0937	389	67
II	E1	02*0939	380-1	31
			276	38
			363	23,68
			373	18,30
			380-1	31
IV	E1	02*0924	393-1	33
IV	E1	02*0924	393-2	34
II	E1	02*0925	392-1	33
II	E1	02*0925	392-2	34
II	E1	02*0926	273	--
			395	50
II	E1	02*0929	580	35
IV	E1	02*0930	580	35
VI	E1	02*0937	389	67
II	E1	02*0939	380-1	31
			276	38
			363	23,68
			373	18,30
			380-1	31
IV	E1	02*0924	393-1	33
IV	E1	02*0924	393-2	34
II	E1	02*0925	392-1	33
II	E1	02*0925	392-2	34
II	E1	02*0926	273	--
			395	50
II	E1	02*0929	580	35
IV	E1	02*0930	580	35
VI	E1	02*0937	389	67
II	E1	02*0939	380-1	31
			276	38
			363	23,68
			373	18,30
			380-1	31
IV	E1	02*0924	393-1	33
IV	E1	02*0924	393-2	34
II	E1	02*0925	392-1	33
II	E1	02*0925	392-2	34
II	E1	02*0926	273	--
			395	50
II	E1	02*0929	580	35
IV	E1	02*0930	580	35
VI	E1	02*0937	389	67
II	E1	02*0939	380-1	31
			276	38
			363	23,68
			373	18,30
			380-1	31
IV	E1	02*0924	393-1	33
IV	E1	02*0924	393-2	34
II	E1	02*0925	392-1	33
II	E1	02*0925	392-2	34
II	E1	02*0926	273	--
			395	50
II	E1	02*0929	580	35
IV	E1	02*0930	580	35
VI	E1	02*0937	389	67
II	E1	02*0939	380-1	31
			276	38
			363	23,68
			373	18,30
			380-1	31
IV	E1	02*0924	393-1	33
IV	E1	02*0924	393-2	34
II	E1	02*0925	392-1	33
II	E1	02*0925	392-2	34
II	E1	02*0926	273	--
			395	50
II	E1	02*0929	580	35
IV	E1	02*0930	580	35
VI	E1	02*0937	389	67
II	E1	02*0939	380-1	31
			276	38
			363	23,68
			373	18,30
			380-1	31
IV	E1	02*0924	393-1	33
IV	E1	02*0924	393-2	34
II	E1	02*0925	392-1	33
II	E1	02*0925	392-2	34
II	E1	02*0926	273	--
			395	50
II	E1	02*0929	580	35
IV	E1	02*0930	580	35
VI	E1	02*0937	389	67
II	E1	02*0939	380-1	31

List of homologation numbers Homologationsnummern

e	E	Typ • type tipo • тип	Tip	Tip
II	E1	01*14069	258	--
II	e1	01*14070	254 +	--
II	e1	01*14071	255	--
			256	--
II	e1	02*14072	258	--
II	e1	02*14073	40.4495.222	--
			253	42
II	e1	01*14075	251	28
II	e1	02*14076	152 AS	--
II	e2	02*14080	364	28
II	e1	02*14082	364	28
II	E1	01*14082	364	28
II	e1	02*14083	282	--
II	E1	01*14083	282	--
II	E1	02*14084	282	--
II	e1	*14085	340 / 341	--
II	e1	*14086	253	42
II	e1	02*14087	340 / 341	--
II	e1	02*14088	249 L	--
II	e1	02*14089	252	60
II	E1	01*14089	252	60
II	e1	02*14090	251	28
II	e1	*14091	253	42
II	e1	02*14092	254	42
II	e1	*14093	253	42
II	e1	*14094	253	42
II	e1	01*14095	254	42
II	e1	01*14096	253	42
II	e1	02*14097	258	--
II	E1	01*14097	258	--
II	e1	02*14098	340 / 341	--
II	E1	01*14098	340 / 341	--
II	e1	02*14099	254	42
II	e1	02*14100	330 / 331	--
II	E1	01*14100	330 / 331	--
II	e1	02*14101	340 / 341	--
II	e1	02*14102	460	--
II	E1	01*14102	460	--
II	e1	02*14103	461	--
II	E1	01*14103	461	--
II	e1	02*14105	368	--
II	e1	02*14108	254	42
II	e1	02*14109	254	42
II	e1	02*14111	385 +	--
II	e1	02*14112	258	--
II	e1	02*14117	280	--
II	E1	01*14117	280	--
II	e1	01*14119	249 L	--
II	e1	02*14121	366	--
II	e1	02*14122	364/1	--
II	e1	02*14123	368	--
II	E1	01*14123	368	--
II	e1	01*14124	340 / 341	--
II	e1	02*14125	370	60
II	E1	01*14125	370	60
II	E1	01*14126	371	60
II	E1	01*14126	371	60
II	e1	02*14142	364	28
II	E13	02*1456	38.3730.410H	--
IV	E13	03*1457	906	18, 23
IV	e1	02*1550	264	--
V	e1	02*1551	264	--
II	E13	02*1558	253	42
III	e1	01*17023	249 A	--
			249 K	51
II	e1	*17087	151 K	--
III	e1	01*17098	249 A	--
			249 K	51
II	e1	*17105	156/4 BO	--
II	e1	*17140	149 K	--
II	e1	01*17149	198	--
III	e1	01*17194	200 (Ford)	--
III	e1	02*17324	196	--
III	e1	02*17335	249 L	51
II		*18792	572	29, 62
II	e4	01*2067	254	42
II	e4	02*2069	259	--
II	E4	01*2069	259	--
II	E6	00*208	250	60
II	e4	01*2083	252	60
II	e1	*2407	244 A ++	--
II	e4	03*2563	373	18, 30
II	E4	02*2563	373	18, 30
II	e1	*2901	156/6 BO	--
II	e3	*30011	472	--
II	e3	*30595	467	--
II	e2	01*307	291	74, 75
II	e3	*32806	467	--
II	e3	*32906	472	--
II	e3	*32908	474 (Iveco)	--
II	e3	*33488	473 (Iveco)	--
II	e3	*33491	472	--
II	e3	*34767	472	--
II	e3	*35216	472	--
II	e3	*35433	472	--
II	e3	*35911	474 (Iveco)	--
II	e3	01*36030	474 (Iveco)	--

e	E	Typ • type tipo • тип	Tip	Tip
II	e3	*36709	340 / 341	--
II	e3	*36710	473 (Iveco)	--
II	e3	*36726	600 (Fiat)	--
II	e11	01*3701	255	--
II	e11	01*3706	364	28
II	e11	01*3709	257	--
II	e11	01*3716	253	42
II	e11	01*3717	252	60
II	e3	*37469	475 (Iveco)	--
II	e3	*38090	472	--
III	e	01*38334	600 (Fiat)	--
II	e3	01*38662	475 (Iveco)	--
II	e3	01*3890	472	--
II	e3	02*3890	472	--
II	e3	01*38930	475 (Iveco)	--
II	e3	01*38961	475 (Iveco)	--
II	e3	01*39267	475 (Iveco)	--
II	e3	02*39267	475 (Iveco)	--
II	e3	01*39542	475 (Iveco)	--
II	e3	*40142	250	60
II	e3	01*40458	473 (Iveco)	--
II	e3	02*40458	473 (Iveco)	--
II	e3	01*40459	473 (Iveco)	--
II	e3	02*40459	473 (Iveco)	--
II	e1	*4051	253	42
II	e3	*41511	475 (Iveco)	--
II	e3	01*41877	474 (Iveco)	--
II	e3	*42453	257	--
II	e3	01*42704	253	42
II	e3	01*42928	258	--
II	e3	02*43355	264	--
II	e3	02*43356	264	--
II	e3	02*43360	472	--
II	e3	*43611	364	28
II	E9	02*4395	286-1	--
II	e3	*44994	258	--
II	e17	00*46002	257	--
II	e3	02*46315	472	--
II	e3	02*46656	460	--
II	E3	01*46656	460	--
V	e3	02*46657	463-1	--
IV	e3	02*46658	462	--
IV	E3	01*46658	462	--
II	e3	02*46919	461	--
II	E3	01*46919	461	--
IV	e11	01*5002	156/6 BO	--
II	e2	02*5004	348	19, 19, 58, 58
IV	e13	01*51370	264	--
II	e11	01*5340	253	42
II	e11	01*5343	257	--
II	e11	01*5383	258	--
II	e11	01*5387	255	--
II	e11	01*5392	364	28
II	e11	01*5393	254	42
II	e11	01*5394	252	60
II	e11	01*5395	251	28
II	e11	01*5396	341	26
IV	e11	01*5398	261	--
IV	e11	01*5399	266	27
IV	e11	01*5420	260	26
II	e11	01*5421	249 L	51
V	e11	01*5422	265	27
II	e11	01*5464	254	42
IV	e11	01*5465	156/6 BO	--
III	e11	01*5502	200 (Ford)	--
II	e3	02*56297	348	19, 19, 58, 58
II	E3	01*56297	470	--
II	e3	02*57571	461	--
II	E3	01*57571	461	--
II	e3	02*58121	460	--
II	E3	01*58121	460	--
IV	e3	02*58232	462	--
IV	E3	01*58232	462	--
II	e11	03*6208	224	62
II	E11	02*6208	224	62
IV	e11	03*6209	224	62
IV	E11	02*6209	224	62
IV	e9	03*6450	580	35
IV	e6	02*6565	261	--
II	e6	02*6566	252	60
II	E6	00*6566	252	60
II	e9	02*6569	373	18, 30
II	E9	02*6569	373	18, 30
IV	E3	02*7010	462	--
IV	E3	02*7012	462	--
II	e3	03*7018	460	--
V	e3	03*7024	463-1	--
II	E6	00*7059	253	42
II	e6	02*7060	253	42
II	e2	02*717	289	68
II	e2	00*718	249 L	--
II	E13	08*7293	253	42
II	e2	02*739	253	42
II	e2	02*740	258	--
II	e2	02*752	286	--
II	E2	00*752	286	--
IV	E2	00*753	287-1	--

e	E	Typ • type tipo • тип	Tip	Tip
II	E2	00*759	254	42
V	e6	02*8104	263	--
III	e13	00*86246	39.3730.210H	--
			39.3730.410H	--
IV	e13	01*87290	264	--
IV	E13	01*87290	264	--
V	e13	01*87291	264	--
IV	E13	01*87291	264	--

NEW

II	E1	02*0902	1039	55
II	E1	021108	1000	63
II	E1	021109	1000	63
II	e1	03*0242	1000	63
II	e1	03*0243	1000	63
II	E1	041469	1039	54
II	E1	041480	1041	41
II	E1	041481	1041	41
II	E1	041540	1000	63
II	E1	041541	1000	63
II	E1	041543	1024	36
II	E1	041619	1027	22
IV	E1	041620	1027	22
III	E1	02*0902	1039	55
IV	E1	041542	1024	36
IV	E1	041482	1041	41
V	E1	041389	1020	37



MEKRA Lang GmbH & Co. KG hat diesen Katalog sorgfältig verfasst. Das Unternehmen entbehrt sich jeglicher Verantwortung für eventuelle Fehler oder Auslassung hinsichtlich Schemen, Zeichnungen, Übereinstimmung mit O.E. Codes usw. und behält sich das Recht vor, ohne Ankündigung, am Inhalt Veränderungen vorzunehmen. Anmerkungen, Fehlerhinweise und weitere Anregungen seitens der Kunden werden gerne entgegen genommen, um die nächste Ausgabe des Kataloges effizienter zu gestalten.

Die Vervielfältigung, auch teilweise, des urheberrechtlich geschützten Inhalts des vorliegenden Kataloges ist ohne schriftliche Genehmigung durch die MEKRA Lang GmbH & Co. KG untersagt.

Sämtliche im Katalog genannten Sachnummern der Fahrzeughersteller und deren Markennamen sowie Prüfnummern anderer Spiegelhersteller dienen lediglich zu Vergleichszwecken.



MEKRA Lang GmbH & Co. KG has devoted its best attention to the editing of this catalogue; it nevertheless declines any responsibility for possible mistakes or omissions regarding figures, drawings, correspondence with O.E. codes etc. and it reserves the right to modify the contents without prior notice. Users' comments, reports of inaccuracies or any other suggestions which may in any way improve the next edition of this catalogue are warmly welcomed.

It is forbidden to reproduce, even partially, the contents of this catalogue without prior written consent of MEKRA Lang GmbH & Co. KG, who will protect its right in accordance with the law.

All vehicle manufacturers' reference numbers, mentioned in the catalogue, as well as their brand names and approval numbers of other mirror manufacturers are only for identification purposes.

Vergleichsliste nach OE-Nummern Cross-reference-table

OE		
Adria Mobil		
9090 83003 00	20.2710.650	39
9095 83001 00	59.2760.005.001	--
9095 83001 00 A	59.2761.302	--
9095 83002 00	59.2760.006.001	--
9095 83010 00	59.1018.001.099	72
9095 83011 00	59.1018.002.099	72
9095 83012 00	12.1018.001.099	72
9095 83013 00	12.1018.002.099	72
9095 83014 00	12.1018.007.099	72
9095 83015 00	12.1018.009.001	72
9095 83016 00	12.1018.010.001	72
9095 83017 00	09.2910.005.099	72,75
9095 83018 00	09.2910.002.099	72,75
9095 83021 00	59.1018.025.001	--
RD 322 077 0	11.3730.210H	18,23,38,68,73
RD 322 244 0	19.1018.311.099	72
Bürstner		
202204008	11.3730.210H	18,23,38,68,73
2193829	12.1018.001.099	72
2193831	12.1018.002.099	72
2193831 MIT ANT	12.1018.012.001	--
2193839	12.1018.009.001	72
2193840	12.1018.010.001	72
2193841	12.1018.007.099	72
2218516	09.2910.002.099	72,75
2218519	09.2910.005.099	72,75
2247710	59.1018.021.001	--
2247727	59.1018.022.001	--
2247751	59.1018.023.001	--
2276379	59.1018.007.099	72
2304574	12.1018.005.099	72
2613741	59.1018.025.001	--
Z60000	20.2710.650	39
Z98889	51.3200.147H	26
Z98892	58.2481.012	--
Z98893	58.2481.011H	--
68152322	59.2782.120	--
70025517	59.2910.003.001	74
70026237	59.2910.500.001	--
70026787	59.2781.120	39
70026788	20.2710.630	--
70026789	59.2910.017.001	74
70026790	61.2910.005.001	75
70026792	09.2910.002.099	72,75
70027178	61.2910.006.001	75
70027535	55.2561.010	--
70027665	51.2540.140H	42
70028068	61.2530.110H	42
70028741	55.2561.110	--
70029007	59.2770.210.099	40
70029251	15.2780.840	39,41,75
70029917	19.2910.001.099	41,75
70029941	15.2780.840	39,41,75
70029942	15.2780.870	39
70030418	59.2780.110	--
70030686	11.2910.007.000	75
70030687	11.2910.006.000	75
70030868	20.2780.631	--
70030875	19.2910.002.099	41,75
70030923	59.2780.120.099	39
70031268	11.2910.002.000	75
70031577	11.2910.001.000	75
70031996	11.2910.008.000	75
70032095	11.2910.003.000	75
70032122	61.2910.011.002	--
70032360	59.2910.014.001	74
70032377	59.2910.013.001	74
70033394	59.2910.009.001	74
70034438	61.2910.012.002	--
70034479	19.2910.001.099	41,75
70034480	19.2910.002.099	41,75
70034551	59.2780.160.001	39
70036218	61.2910.010.002	--
70036219	11.2910.011.002	75
70036220	61.2910.009.002	--
70036705	15.3802.840H	23,68
70037106	20.2710.620	38,39,77
70037291	11.2910.012.002	75
Carthago		
118000	59.2743.332	--
118015	59.2743.322	--
118016	20.2710.121	73
118017	20.2710.630	--
118023	20.2710.111H	73
118029	20.2710.200H	38,73
120565	56.3491.110H	51,63
120666	56.3492.110H	51,63
201619	12.1018.001.099	72
201620	12.1018.002.099	72
201621	12.1018.007.099	72
201622	12.1018.007.099	72
201623	12.1018.008.000	--
201624	12.1018.008.000	--
201931	09.2910.004.099	75
201932	15.2780.841F	39,72,75

OE		
Carthago		
201933	19.1018.311.099	72
201934	19.1018.312.099	72
203722	59.2910.019.001	74
203723	59.2910.020.001	74
207192	59.1018.007.099	72
207193	59.1018.008.099	72
207194	12.1018.005.099	72
207195	12.1018.009.001	72
207196	12.1018.010.001	72
107977	51.1009.017.099	69
110485	51.1009.246.001	--
112137	51.2510.127H	28
112415	55.2020.171	--
372807603	51.1009.025.099	--
3728076-03	51.1009.025.099	69
Case New Holland (CNH)		
00437650	51.3850.227	66
47922739	51.1036.009.099	71
47922741	51.1036.010.099	71
47922743	51.1036.007.099	71
47922744	51.1036.008.099	71
48025196	19.1036.005.099	71
48025209	19.1036.006.099	71
Caterpillar		
236-5334	09.2500.300	--
290-5544 / 319-6789	51.3635.201	23,68
294-1991 / 316-6791	51.3635.204	23,68
294-1992	51.3636.204	23,68
308-3844	15.3731.470H	18,38,73
319-6787	11.3730.210H	18,23,38,68,73
3196788	51.3636.201	23,68
319-6790	51.3636.204	23,68
372-8075	51.1009.017.099	69
372-8076	51.1009.246.001	--
4153114	56.2660.147H	27
4362886	51.1009.027.001	--
436-2886	51.1009.027.099	69
4362887	51.1009.242.001	--
436-2887	51.1009.242.099	69
436-2890	20.1016.004.000	78
438-6751	09.3200.340	--
443-2540	51.1009.248.001	--
4432541	51.1009.243.001	--
443-2541	51.1009.244.001	--
508-0795 ALT	51.1009.009.099	69
526-5057	51.1009.001.099	69
Claas		
11578380	40.1009.004.099	69
11578530	11.1009.004.000	--
11578540	51.1009.048.099	--
11578550	40.1009.002.099	69
11617700	11.1036.011.099	71
11617720	11.1036.012.099	71
11617730	19.1036.007.099	71
11617740	19.1036.008.099	71
11653120	40.1009.001.000	69
11654100	51.1009.001.099	69
11654110	61.1009.001.099	69
11654120	61.1009.002.099	69
11683170	40.1009.002.000	69
11683190	51.1009.049.099	69
1817890	11.3400.510	69
21971360	51.1009.097.099	69
22332170	51.1009.113.099	69
26079370	51.1036.023.099	71
26079500	51.1036.024.099	71
26143870	51.1009.017.099	69
5591600	56.2660.003.001	69
5806090	40.3300.318	--
5854370	51.3300.137	--
6259300	40.3305.218	--
6439980	56.2650.121H	27
Concorde		
248268	59.2910.013.001	74
248269	59.2910.014.001	74
28421	15.2780.840	39,41,75
284213	59.2910.019.001	74
284214	59.2910.020.001	74
284215	59.2910.001.001	74
284215-01	11.2910.011.002	75
284215-03	61.2910.011.002	--
284215-07/28421	19.2910.001.099	41,75
284215-10	15.2780.840	39,41,75
284215-10/28421	15.2780.840	39,41,75
284216	59.2910.002.001	74
284216-01	11.2910.012.002	75
284216-02	11.2910.008.000	75
284216-03	61.2910.012.002	--
284217	61.2910.021.001	75
284218	61.2910.022.001	75
284217-3	61.2770.901.099	40
284221	09.2910.002.099	72,75
284222	20.2710.650	39
284223	20.2710.630	--

OE		
Concorde		
284224	59.2780.130	39
2842241	11.2780.910	39
284225	59.2780.230	39
2842251	11.2780.920	39
284226	15.2711.114	38,73
284228	15.2712.114	38,73
284230	59.2710.401H	73
284232	59.2710.402H	73
284233	59.2710.406	73
284237	20.2710.500	--
2842372	11.3730.210H	18,23,38,68,73
284240	20.2480.216H	38,50,73,77
284242	20.2480.217H	38,50,73,77
284248	15.3731.470H	18,38,73
284260	59.1018.003.099	72
284261	59.1018.004.099	72
284262	12.1018.001.099	72
284263	12.1018.002.099	72
284264	12.1018.003.099	72
284265	12.1018.009.001	72
284266	12.1018.010.001	72
284267	09.2910.005.099	72,75
284273	59.2910.009.001	74
284274	59.2910.010.001	74
284277	59.2910.017.001	74
284278	59.2910.018.001	74
284281	19.2910.002.099	41,75
284282	11.2910.016.000	--
284283	11.2910.017.000	--
284284	11.2910.014.000	--
DAF		
1401046	59.5580.147	--
1404849 / 1796325	40.3485.403H	19,58
1404868	61.3482.149H	19,58
1404871	61.3480.149H	19,58
1405295	61.3480.149H	19,58
1405350	61.3482.149H	19,58
1409570	59.5580.147	--
1409962	59.5580.247H	22,58,61
1425104	61.3730.324H	18
1425105	61.3730.326H	18
1425108	61.3860.214H	18
1425109	15.3731.470H	18,38,73
1425111	15.3861.114H	18
1425113	11.3730.210H	18,23,38,68,73
1425114	11.3860.500H	18
1525537	59.5520.530H	66
1525547	59.3652.167H	--
1525548	59.3652.147H	--
1525593	56.1561.116H	--
1525594	56.1561.115H	--
1525630	51.3640.127	--
1525672	51.1523.111H	--
1525673	51.1522.211H	--
1525685	40.3200.422H	26
1526649	59.5580.247H	22,58,61
1527629	59.5580.147	--
1542333	51.3635.206	23,68
1542334	51.3636.206	23,68
1610182	15.3862.174H	18
1610184	61.3730.326H	18
1610186	61.3730.324H	18
1610187	61.3860.214H	18
1610189	61.3865.124H	18
1610190	15.3731.470H	18,38,73
1610191	15.3861.114H	18
1614022	59.5520.240H	21
1644323	20.5700.420H	20
1644324	20.5700.410H	20
1644325	11.5700.100H	20
1644326	11.5710.110H	20
1669573	59.5520.230H	21
1670877	61.9065.114H	18,23
1670878	15.9060.870H	18,23
1670888	11.9060.100H	18,23
1684030	59.5595.131H	21
1684031	59.5595.132H	21
1684033	59.5595.134	21
1684034	59.5595.135	21
1684035	59.5595.136	21
1684042	59.5595.235H	21
1684043	59.5595.236	21
1684046	59.5595.331H	21
1684047	59.5595.332	21
1685324	58.5701.104.099	20
1685325	58.5700.001.099	20
1685330	15.5701.840H	20
1685331	15.5711.870H	20
1689347	61.5710.310.099	20
1689348	61.5700.310.099	20
1692		

OE			OE			OE		
DAF			Eura Mobil			Iveco		
1700306	59.3900.243H	22,56,61	200070751	09.2910.002.099	72,75	5010482937	59.2810.211H	--
1701288	59.5524.648.099	22,57,61	200070813	12.1018.007.099	72	5010482938	59.2810.213H	--
1704604	59.3900.243H	22,56,61	200070814	12.1018.009.001	72	503449902	11.2770.920	40
1704605	59.3900.233H	22,56,61	200070817	12.1018.001.099	72	503449909	15.2771.840	40
1704627	59.5524.648.099	22,57,61	200070820	12.1018.002.099	72	503651179	11.2770.920	40
1709389	59.1025.002.099	21,58,62	200070822	12.1018.010.001	72	504132249	56.4620.247H	--
1709390	59.1025.001.099	21,58,62	200083487	59.2760.005.001	--	504150526	59.1008.005.099	24
1733892	58.3900.143H	--	200083496	59.2760.006.001	--	504150527	59.1008.006.099	24
1733893	58.3900.243H	--	V110-01-008B	11.3730.210H	18,23,38,68,73	504150538	59.1008.011.099	24
1735519	61.3900.110H	22,56,57,61	V110-02-001	51.3400.147H	26	504150539	59.1008.012.099	24
1735520	61.3900.120H	22,56,57,61	V110-02-004	09.3200.340	--	504150551	59.1008.017.099	24
1735521	61.3900.100H	22,56,57,61	Fendt/Valtra			504150552	59.1008.018.099	24
1735522	61.3911.110H	22,56,61	F297810150010	40.2890.222H	66,68	504168235	56.1008.001.099	24
1735523	61.3911.120H	22,56,61	F304810150030	40.1009.002.000	69	504168236	56.1008.002.099	24
1736853	58.3900.233H	--	F743810150010	40.1009.001.000	69	504168244	11.1008.001.099	24
1736854	58.3900.133H	--	G297810150030	51.3850.127H	66	504197878	19.1008.041.099	24
1736865	15.3911.872H	22,56,61	G304810150020	51.1009.017.099	69	504197879	19.1008.311.099	24
1736879	15.3911.871H	22,56,61	G816810150030	51.2890.117H	68	504224428	55.1008.002.099	25
1736883	11.3910.200H	22,56,61	ACV0148490	51.1009.097.099	69	504369910	59.1008.005.099	24
1736884	11.3900.200H	22,56,61	ACV0759270	40.1009.004.099	69	504369961	59.1008.006.099	24
1736891	08.5752.024.099	22,39,40,56,57,61	ACV0759280	40.1009.002.099	69	504369979	59.1008.017.099	24
1736892	08.5752.024.099	22,39,40,56,57,61	ACV0805960	51.1009.017.099	69	504369995	59.1008.018.099	24
1736923	20.3900.520H	22,56,57,61	Heulliez			504370048	59.1008.011.099	24
1736924	20.3900.510H	22,56,57,61	50344917	15.2780.840	39,41	504370055	59.1008.012.099	24
1736953	58.3900.233H	22,56,61	HINO			5801334610	59.1008.006.099	24
1736954	58.3900.133H	22,56,61	879020002	51.3300.147H	--	5801334614	59.1008.005.099	24
1737933	15.3900.840H	22,56,57,61	879020008C	11.9060.100H	18,23	5801336285	59.1008.011.099	24
1781226	61.3902.100E	--	HINO			5801336298	59.1008.012.099	24
1788487	58.5710.001.099	20	879020009	59.3604.178H	--	5801341206	59.1008.017.099	24
1788972	58.5713.114.099	20	879020009G	40.3605.203H	60	5801341207	59.1008.018.099	24
1796324	61.3482.149H	19,58	879020010	59.5524.820	--	5801404796	59.2770.211.099	40
1805712	61.3480.149H	19,58	879020011	51.5524.930H	22,57,61,67	5801404799	59.2762.101	38
1805713	40.3485.412H	19,58	879020017	51.3636.206	23,68	5802498968	112.790.001.099	25
1805714	61.3481.149H	19,58	87902003	56.9065.110	18,23	5802498969	112.790.002.099	25
1805717	15.3480.840H	19,58	87902007C	11.3730.210H	18,23,38,68,73	93190970	15.4601.164H	--
1812859	58.5713.114.099	20	87902007G	15.3802.840H	23,68	93190974	20.4601.100H	--
1812862	61.5700.310.099	20	87902008	61.9065.114H	18,23	93190977	15.4611.164H	--
1812865	09.5700.002.099	20	87902008G	15.9060.870H	18,23	98472977	20.4611.100H	--
1812867	58.5701.104.099	20	87930-0008A	59.2652.110H	27	98472979	51.4601.120H	--
1816902	59.5595.131H	21	Hyster			98472983	51.4601.130H	--
1816903	59.5595.132H	21	0850034	40.3640.322H	28	Johns Deere		
1816905	59.5595.134	21	1015718	55.2020.177H	--	AKK34593	51.1009.113.099	69
1816906	59.5595.135	21	1287034	59.2761.302	--	AL158964	51.3850.127H	66
1816907	59.5595.136	21	1289691	20.2480.222	--	AL203151	15.5701.840H	20
1816912	59.5595.235H	21	1299452	20.2700.200H	38,73	AL225823	19.1036.007.099	71
1816913	59.5595.236	21	1316712	58.2704.065	--	AL225824	19.1036.008.099	71
1816914	59.5595.331H	21	2668945	11.2780.920	39	AL232743	19.1036.009.099	71
1816915	59.5595.332	21	2673925	20.2710.620	38,39,77	AL232744	51.1036.010.099	71
1817860	61.5710.310.099	20	2674190	51.3200.137H	--	AZ100260	56.2650.121H	27
1818353	58.5710.001.099	20	2698041	40.3640.322H	28	AZ100261	11.1523.010	--
1830338	61.5590.001.099	21,75	2698081	09.3200.360	--	AZ104094	51.3636.205	--
1830562	58.5700.001.099	20	2698087	56.1471.117	--	AZ104180	51.3635.205	--
1882113	12.5740.002.099	20	2725823	11.3730.210H	18,23,38,68,73	AZ65395	40.3300.318	--
1940334	58.5700.003.002	20	2726750	59.2761.112	--	R566924	11.1036.011.099	71
1940335	58.5700.004.002	20	2771210	40.2500.322	--	Kässbohrer		
1940341	61.5740.001.099	20	2943025	20.2760.140	--	8.688.000.244.0	40.2520.422H	60
1940342	19.5740.311.099	20	2943027	20.2760.150	--	8.688.000.256.0	09.3200.320H	76
1949304	59.1005.001.099	21	38.305	56.1471.117	--	8.688.032.13.0	10.6321.100	26,27
1949305	59.1005.002.099	21	383183	51.2510.127H	28	8.688.100.253.0	40.2890.422H	66,68
2248157	59.1027.001.099	22	V110-02-005	40.3640.322H	28	8.688.105.262.0	09.3200.340	--
2248158	59.1027.002.099	22	Irisbus			8.688.105.264.0	11.3730.210H	18,23,38,68,73
2248159	59.1005.011.099	23	42545989	15.2712.114	38,73	8.688.117.000.0	51.1009.250.001	--
2248160	12.1027.103.099	22	42545990	11.3730.210H	18,23,38,68,73	8.688.120.000.0	51.1009.001.099	69
2248161	12.1027.104.099	22	42548988	15.2711.114	38,73	8.688.128.000.0	59.1017.003.099	70
2248164	12.1027.001.099	22	5006232165	58.2704.088	79	8.688.129.000.0	59.1017.004.099	70
2248165	12.1027.002.099	22	5006232166	58.2704.089	--	8.748.026.000.0	55.2462.117	--
2248166	12.1027.005.099	22	5006232482	51.3732.326	38,73	8.748.036.000.0	56.1562.110	--
2248167	12.1027.006.099	22	71101611	59.2710.411	--	814.67.10.100.1	51.2520.147H	60
2248168	12.1027.015.099	22	71101611/612 SO	20.2710.200H	38,73	86881000000	51.3850.247	66
2248169	12.1027.016.099	22	71101612	59.2710.412	--	86881050000	51.3635.206	23,68
2248172	12.1027.107.099	22	Irisbus			86881052630	15.3802.840H	23,68
2248173	12.1027.108.099	22	71701878	09.3200.220	76	86881060000	51.3636.206	23,68
2248174	12.1005.001.099	23	Iveco			99707305609	40.2660.404H	27
2248175	59.1027.003.099	22	2996670	56.4620.247H	--	KFB		
2248176	59.1027.004.099	22	2996671	56.4620.267H	--	Y07001023	51.3850.147H	66
2248178	59.5590.013.099	23	42309921	51.1523.111H	--	Komatsu		
2248179	59.5590.014.099	23	42545983	59.2710.412	--	21D-54-41710	51.1009.017.099	69
2248184	12.5590.009.099	23	42545985	20.2480.217H	38,50,73,77	42154H3380	51.1009.025.099	69
2298758	12.1027.203.099	22	42556228	11.3730.210H	18,23,38,68,73	42154H3480	51.1009.017.099	69
2298759	12.1027.204.099	22	42556227	15.3731.470H	18,38,73	Kramer		
2298826	12.1027.207.099	22	500086749	192.790.012.099	25	1000379630	51.1009.022.099	69
2298827	12.1027.208.099	22	500086750	192.790.011.099	25	1000379641	51.1009.122.099	69
2306586	61.1029.224.099	22	500086753	192.790.031.099	25	1000386860	51.1009.017.099	69
2306587	61.1024.224.099	22	500086754	192.790.032.099	25	1000390196	51.1009.149.099	69
2306590	19.1027.011.099	22	5001851891	11.2810.200H	50	1000396281	51.1009.097.099	69
2306591	19.1027.012.099	22	5001851897	08.2810.124	--	Krone		
2306592	19.1027.311.099	22	5001852000	20.2810.310	--	270011780	51.3635.201	23,68
2306593	19.1027.312.099	22	5001861684	40.2816.403	--	Liebherr		
Dennis Eagle			5010403393	09.2810.400	--	10218823	55.3000.108H	--
	1055967	--	5010404852	59.2810.113H	50			
	68152255	39	5010411090	59.2810.111H	50			
Eura Mobil								
200070726	59.1018.001.099	72						
200070727	59.1018.002.099	72						
200070749	09.2910.005.099	72,75						

Vergleichsliste nach OE-Nummern Cross-reference-table

OE			MAN	OE			MAN	OE			MAN
Liebherr											
10285254	55.2020.177H	--	36.63732-0001	11.2770.302	40	81.63730-6420	51.3412.120H	26			
10287949	51.3636.206	23,68	36.63732-0002	11.2770.202	40	81.63730-6421	56.2662.120H	27			
10287953	51.3635.206	23,68	36.63732-0003	11.2770.406	40	81.63730-6430	51.3921.222H	32			
10300676	56.2600.127H	26	36.63732-0004	11.2770.620	--	81.63730-6431	51.3924.222H	--			
10303351	51.3640.137H	28	36.63732-0006	11.2780.920	39	81.63730-6432	51.3922.222H	32			
10334227	11.3730.210H	18,23,38,68,73	36.63732-0024	61.2910.009.002	--	81.63730-6433	51.3923.222H	32			
10342167	09.2070.101H	26,28,42,60,68,76	36.63732-0044	11.2910.017.000	--	81.63730-6434	51.3922.232H	--			
10470601	15.3802.840H	23,68	36.63732-6000	61.2770.900.009	40	81.63730-6443	56.3931.222H	32			
10472808	58.2600.010H	--	36.63733-0009	19.2910.002.009	41,75	81.63730-6444	56.3932.222H	32			
10472809	56.2600.147H	27	36.92611-0002	11.2770.040	--	81.63730-6480	51.3921.223H	33			
10675116	40.2635.204F	--	65.63733-0002	19.1013.011.009	37	81.63730-6481	51.3922.223H	33			
10877369 / 5707 57877	51.2520.127H	60	65.63733-0006	19.1013.013.009	37	81.63730-6482	51.3921.224H	33			
11008727	51.3640.128.001	--	--	19.1013.013.009	37	81.63730-6483	51.3922.224H	33			
11066581	58.2704.075.001	--	65.63733-0015	19.1013.011.009	37	81.63730-6484	51.3924.223H	--			
11068341	51.1009.017.099	69	81.25404-6247	09.3200.310H	--	81.63730-6485	51.3923.223D	33			
11181691	51.1009.049.001	--	81.25406-6252	09.3200.360	--	81.63730-6486	51.3924.224H	33			
11182172	09.2070.101H	26,28,42,60,68,76	81.25432-0149	09.2070.101H	26,28,42,60,68,76	81.63730-6487	51.3923.224H	33			
1118692	09.2000.301H	26,27,66,69,76	81.25505-6247	08.2770.001.000	40	81.63730-6492	51.3922.233H	--			
11657850	61.3480.149H	19,58	81.25525-0232	08.3200.233H	39,40,72,75,76	81.63730-6510	56.3931.343H	33			
11657851	58.1016.001.099	78	81.62410-0107	20.5800.710H	35	81.63730-6511	56.3932.343H	33			
11657852	58.1016.002.099	78	81.62410-0108	20.5800.720H	35	81.63730-6512	56.3931.323H	33			
11657853	58.1016.005.099	78	81.62410-0109	20.5800.750H	35	81.63730-6513	56.3932.323H	33			
11657854	58.1016.006.099	78	81.62730-6221	51.3410.147H	26	81.63730-6529	59.5800.101H	35			
11657855	20.1016.004.000	78	81.633732-0089	61.2772.100	40	81.63730-6531	59.5800.201H	35			
11830241	11.1200.502.099	--	81.6370-0032	40.3640.422H	26,28	81.63730-6533	59.5800.121H	35			
11830530	59.1005.004.001	--	81.63730-	51.3922.222H	32	81.63730-6534	59.5800.221H	35			
11931048	20.2710.630	--	81.63730 -6127/-6167	51.2510.127H	28	81.63730-6549	59.5800.122H	35			
12218370	59.1005.004.001	--	81.63730-0032	40.3640.422H	26,28	81.63730-6550	59.5800.222H	35			
12230063	40.1009.001.000	69	81.63730-0058	08.3400.324	--	81.63730-6551	59.5800.422H	35			
12230064	40.1009.003.099	--	81.63730-0067	15.3731.074H	30	81.63730-6552	59.5800.322H	35			
12254474	09.3200.320H	76	81.63730-0082	81.2770.110	--	81.63730-6553	59.5800.223H	35			
12269787	58.1016.004.099	78	81.63730-0083	61.2770.210	40	81.63730-6560	59.5800.120H	35			
571070008	09.2070.101H	26,28,42,60,68,76	81.63730-0066	15.3731.070H	30	81.63730-6561	59.5800.202H	35			
571229808	40.2520.422H	60	81.63730-6001	51.3640.147H	28	81.63730-6562	59.5800.402H	35			
571572108	09.3200.340	--	81.63730-6003	40.3640.422H	26,28	81.63730-6563	59.5800.302H	35			
571572208	09.3200.220	76	81.63730-6016	51.3400.147H	26	81.63730-6564	59.5800.203H	35			
571757008	08.3492.324.099	--	81.63730-6094	51.2460.218H	--	81.63730-6573	56.5790.004.099	29,32,45,47			
591055977	59.2640.110H	--	81.63730-6108	51.3640.127H	28	81.63730-6574	56.5790.003.099	29,32			
591056608	51.2520.147H	60	81.63730-6126	51.3640.127H	28	81.63730-6578	56.5790.002.099	34,35			
591059377	56.2660.127H	27	81.63730-6128	51.2510.147H	28	81.63730-6733	56.5790.004.099	29,32,45,47			
591060808	56.2640.127H	--	81.63730-6138	56.1562.110	--	81.63730-6734	56.5790.003.099	29,32			
591061008	56.2661.147	--	81.63730-6147	51.3640.127H	28	81.63730-6735	56.5790.002.099	34,35			
591069208	09.3200.440	--	81.63730-6148	51.3640.127H	28	81.63730-6738	51.3920.002.099	34			
591070908	56.2630.127	--	81.63730-6149	51.3640.127H	28	81.63730-6739	51.3921.001.099	34			
591077608	58.2704.042	--	81.63730-6151	51.3640.147H	28	81.63730-6740	51.3920.003.099	34			
591080008	58.2486.507	--	81.63730-6193	51.3200.147H	26	81.63730-6741	51.3920.013.099	34			
7004956	51.1524.119H	68	81.63730-6194	51.3640.127H	28	81.63730-6743	51.3920.005.099	34			
7005028	51.3640.127	--	81.637306202	40.3640.422H	26,28	81.63730-6744	51.3920.012.099	34			
7017444	56.2660.127H	27	81.63730-6202	40.3640.422H	26,28	81.63730-6745	51.3920.004.099	34			
7021442	51.3640.147H	28	81.63730-6206	56.2600.127H	26	81.63730-6746	51.3920.014.099	34			
7022092	51.2461.117H	--	81.63730-6220	51.3410.127H	26	81.63730-6748	56.3930.004.099	34			
7616670	51.1523.121H	--	81.63730-6221	51.3410.147H	26	81.63730-6749	56.3930.002.099	34			
7619627	55.2021.177	--	81.63730-6222	56.2660.127H	27	81.63730-6750	56.3930.003.099	34			
7621216	20.2480.210H	77	81.63730-6223	56.2660.147H	27	81.63730-6751	56.3930.001.099	34			
7621717	51.2530.128H	--	81.63730-6224	56.2650.121H	27	81.63730-6753	51.5720.001.099	--			
			81.63730-6233	51.3410.127H	26	81.63730-6754	56.2660.002.099	27			
			81.63730-6234	51.3410.147H	26	81.63730-6755	59.5800.122H	35			
			81.63730-6235	56.2660.127H	27	81.63730-6756	59.5800.102H	35			
			81.63730-6236	56.2660.147H	27	81.63730-6757	59.5800.422H	35			
			81.63730-6237	59.2652.110H	27	81.63730-6758	59.5800.402H	35			
			81.63730-6294	59.3652.128H	27	81.63730-6761	59.5800.223H	35			
			81.63730-6295	59.3652.147H	--	81.63730-6762	59.5800.222H	35			
			81.63730-6296	59.3652.167H	--	81.63730-6764	59.5800.322H	35			
			81.63730-6299	56.2660.147H	27	81.63730-6765	59.5800.202H	35			
			81.63730-6303	51.3736.121H	30	81.63730-6767	59.5800.302H	35			
			81.63730-6305	51.3736.126H	30	81.63730-6770	59.5800.203H	35			
			81.63730-6306	56.3860.112H	30	81.63730-6843	56.1020.020.099	37			
			81.63730-6307	56.3860.114H	30	81.63730-6844	56.1020.019.099	37			
			81.63730-6308	56.3862.116H	30	81.63730-6845	56.1020.017.099	37			
			81.63730-6314	51.3735.121H	30	81.63730-6846	56.1020.018.099	37			
			81.63730-6315	51.3735.124H	30	81.63730-6853	59.1024.009.099	36			
			81.63730-6316	51.3735.126H	30	81.63730-6854	59.1024.010.099	36			
			81.63730-6317	56.3861.116H	30	81.63730-6855	59.1024.027.099	36			
			81.63730-6328	56.3862.116H	30	81.63730-6856	59.1024.028.099	36			
			81.63730-6331	51.3735.121H	30	81.63730-6859	59.1024.001.099	36			
			81.63730-6332	51.3736.121H	30	81.63730-6860	59.1024.002.099	36			
			81.63730-6345	51.3921.222H	32	81.63730-6861	59.1024.023.099	36			
			81.63730-6347	51.3922.222H	32	81.63730-6862	59.1024.024.099	36			
			81.63730-6350	56.3932.222H	32	81.63730-6863	59.1024.021.099	36			
			81.63730-6351	56.3931.122H	32	81.63730-6865	59.1024.017.099	36			
			81.63730-6361	51.3735.124H	30	81.63730-6868	59.1024.014.099	36			
			81.63730-6362	51.3736.124H	30	81.63730-6869	59.1024.013.099	36			
			81.63730-6363	51.3735.126H	30	81.63730-6870	59.1024.030.099	36			

OE		
MAN		
81.63731-0309	11.3921.400	33,34
81.63731-0356	11.5800.100H	35
81.63731-0366	11.3921.400	33,34
81.63731-0372	61.2770.111	--
81.63731-0373	61.2770.211	40
81.63731-0380	11.5800.200H	35
81.63731-0397	11.5800.100H	35
81.63731-6468	20.2710.121	73
81.63731-6469	20.2710.111H	73
81.63731-6470	20.2480.222	--
81.63731-6471	20.2480.221	--
81.63731-6474	20.2700.240	--
81.63731-6475	20.2700.230	--
81.63731-6477	58.2710.101	--
81.63731-6478	20.2480.223	77
81.63731-6539	20.2710.132D	--
81.63731-6540	20.2710.142D	--
81.63731-6638	58.5800.101H	35
81.63731-6639	58.5800.102H	35
81.63731-664	58.5800.202H	35
81.63731-6640	58.5800.201H	35
81.63732-0019	14.2530.100	--
81.63732-0044	11.3800.300H	31
81.63732-0045	11.3810.300H	--
81.63732-0046	51.3736.124H	30
81.63732-0047	51.3736.126H	30
81.63732-0048	56.3862.116H	30
81.63732-0049	56.3861.116H	30
81.63732-0050	56.3860.114H	30
81.63732-0051	51.3735.126H	30
81.63732-0054	11.3921.110H	32,33
81.63732-0056	11.3931.120H	32,33
81.63732-0057	11.3931.110H	32,33
81.63732-0058	11.3730.210H	18,23,38,68,73
81.63732-0059	11.3921.120H	32,33
81.63732-0061	11.3931.110H	32,33
81.63732-0062	11.3931.120H	32,33
81.63732-0063	11.3921.120H	32,33
81.63732-0065	11.3931.110H	32,33
81.63732-0066	11.3931.120H	32,33
81.63732-0073	20.5800.410H	35
81.63732-0074	20.5800.420H	35
81.63732-0075	20.5800.610H	35
81.63732-0076	20.5800.620H	35
81.63732-0078	11.3810.300H	--
81.63732-0087	11.2770.920	40
81.63732-0088	11.2780.910	39
81.63732-0090	20.5800.750H	35
81.63732-0091	13.5800.100H	35
81.63732-0094	12.3920.001.099	34
81.63732-0095	12.3920.002.099	34
81.63732-0096	12.3930.001.099	34
81.63732-0097	12.3930.002.099	34
81.63732-0098	11.2780.520	--
81.63732-0106	12.1020.003.099	37
81.63732-0110	13.1024.002.099	36
81.63732-0111	13.1024.001.099	36
81.63732-0112	12.1024.012.099	36
81.63732-0113	12.1024.011.099	36
81.63732-0114	12.1024.010.099	36
81.63732-0115	12.1024.009.099	36
81.63732-0125	13.1024.003.099	36
81.63733-0032	40.2510.222H	28
81.63733-0025	40.3640.222H	26,28
81.63733-0030	40.3640.222H	26,28
81.63733-0036	40.3200.422H	26
81.63733-0042	40.2605.204H	26
81.63733-0060	40.3640.222H	26,28
81.63733-0061	40.2665.204H	27
81.63733-0064	40.3640.422H	26,28
81.63733-0066	15.3731.070H	30
81.63733-0067	15.3731.074H	30
81.63733-0075	15.3731.470H	18,38,73
81.63733-0082	15.3921.870H	32
81.63733-0083	15.3922.870H	32
81.63733-0085	15.3931.870H	32
81.63733-0097	15.3811.870H	31
81.63733-0098	15.3811.870H	31
81.63733-0099	15.3946.670F	27
81.63733-0101	40.5725.212H	29
81.63733-0103	40.5725.412H	29,62
81.63733-0104	40.5735.203H	29
81.63733-0106	40.5735.403H	29,62
81.63733-0110	15.2771.840	40
81.63733-0111	15.2771.870	40
81.63733-0112	15.2780.870	39
81.63733-0113	15.2780.840	39,41,75
81.63733-0114	15.2561.640	--
81.63733-0115	15.2561.600	--
81.637330-6003	40.3640.422H	26,28
81.63733-064	40.3640.422H	26,28
81.63733-6003	40.3640.422H	26,28
81.63733-6007	40.2660.404H	27
81.63733-6029	15.3731.470H	18,38,73
81.63733-6033	15.3921.870H	32
81.63733-6034	15.3922.870H	32
81.63733-6037	15.3931.870H	32

OE		
MAN		
81.63733-6049	15.3920.840H	33
81.63733-6057	15.3932.870H	33
81.63733-6071	15.5801.840H	35
81.63733-6072	15.5811.872H	35
81.63733-6073	15.5811.871H	35
81.63733-6074	15.5791.470H	29,32,45,47
81.63733-6078	15.5791.570.099	29,32,34,35
81.63733-6079	19.3920.011.099	34
81.63733-6080	19.3930.311.099	34
81.63733-6083	19.1024.011.099	36
81.63733-6084	19.1024.012.099	36
81.63733-6085	19.1024.311.099	36
81.63733-6086	19.1024.312.099	36
81.63733-6087	19.1020.213.099	37
81.63733-6088	19.1020.613.099	37
81.63734-6001	08.5752.024.099	22,39,40,56,57,61
81637306374	51.3732.326	38,73
81637306375	51.3731.326	38,73
81637306390	51.3732.326	38,73
81637310289	20.2710.200H	42,73
81637316470	20.2480.217H	38,50,73,77
81637320058	11.3730.210H	18,23,38,68,73
81637330113	15.2780.840	39,41,75
81637336027	15.2711.114	38,73
81637336028	15.2712.114	38,73
81637336029 /		
81637330075	15.3731.470H	18,38,73
82.25451-6399	09.2500.300	--
82.63730-6015	51.3801.148H	31
82.63730-6016	51.3802.148H	31
82.63730-6017	51.3801.168H	31
82.63730-6018	51.3802.168H	31
82.63730-6021	56.3812.128H	31
82.63730-6022	56.3812.128H	31
82.63730-6023	56.3812.148H	31
82.63730-6024	56.3812.148H	31
82.63730-6025	56.3811.168H	31
82.63730-6026	56.3812.168H	31
82.63730-6033	59.3652.128H	27
82.63730-6034	59.3652.148H	27
82.63730-6035	59.3652.168H	27
83.25402-6010	09.2000.301H	26,27,66,69,76
83.63700-6501	59.2712.114	38
83.63700-6502	59.2712.111	38
83.63700-6510	59.2780.140.001	39
83.63700-6511	59.2780.150.001	40
83.63731-6507	20.2480.216H	38,50,73,77
83637316507	20.2480.216H	38,50,73,77
85.200009601	40.3640.422H	26,28
85.200009602	40.3640.422H	26,28
85.63730-6015	51.3400.147H	26
85.63730-6030	51.5720.120H	29
85.63730-6033	51.5720.140H	29
85.63730-6035	51.5721.160H	29
85.63730-6036	51.5722.160H	29
85.63730-6037	58.5730.120H	36
85.63730-6039	56.5730.140H	29
85.63731-6101	58.3405.261Y	--
85.63731-6102	58.3406.250Y	--
85.63731-6104	58.3406.252Y	--
85.63731-6106	58.3406.254Y	--
85.63731-6107	58.3405.262H	--
85.63731-6108	58.3406.251H	--
85.63731-6109	58.3405.264Y	--
85.63731-6126	58.3402.112Y	--
88.25426-6837	09.2770.210	40
88.25505-0024	09.3200.420H	26,69,71
88.63700-6059	59.2780.120.099	39
88.63700-6060	59.2771.210	40
88.63700-6062	59.2770.211.099	40
88.63700-6063	59.2780.110	--
88.63700-6064	59.2770.110	--
88.63730-6041	51.3400.147H	26
88.63730-6077	55.2561.010	--
88.63730-6078	55.2561.110	--
88.63731-6131	20.2780.630	--
A0048208342	08.3400.324	--
AP138274C-2	11.2780.920	39
N1.01103-5783	58.2601.010	--
81.63732-0124	13.1024.004.099	36
Marco Polo		
09379861018	20.2710.121	73
17294281	20.2710.200H	38,73
172942890	51.3731.326	38,73
Mauser		
6-200.26.185	51.1036.025.099	71
Mercedes		
0018210029	10.6221.100	28,66,68
0001505533	09.2070.101H	26,28,42,60,68,76
0004400015	08.5890.300.099	53,65
0004400115	08.5890.301.099	53,65
0004400515	08.5890.004.099	--
0004401501	08.5890.003.099	--
0008100211	20.2810.110H	--
0008100279	61.3752.147H	43,50

OE		
Mercedes		
0008100379	61.3752.167H	43,50
0008100416	51.2540.120H	42
0008100616	51.2540.130H	42
0008100879	56.3960.148H	45,47
0008101479	51.5750.004.099	44
0008101579	51.5750.002.099	44
0008101679	51.5770.001.099	44
0008101779	51.5750.003.099	44
0008101879	51.5750.001.099	44
0008102016	51.2540.130H	42
0008102079	51.5750.001.099	44
0008102179	51.5750.002.099	44
0008102279	51.5750.003.099	44
0008102316	51.2530.140H	42
0008102379	51.5750.004.099	44
0008102479	51.5770.001.099	44
0008102716	51.2530.120H	42
0008103613	61.3000.001.001	67
0008103713	61.3000.002.001	67
0008104816	51.2540.120H	42
0008106216	51.2530.120H	42
0008109516	61.3782.147H	46
0008109616	61.3772.147H	43,46
0008110239	61.2530.110H	42
0008110361	20.3750.710.099	43
0008110461	20.3750.720.099	43
0008111122	13.5890.210.199	53,55,65
0008111233	51.2530.120H	42
0008111307	61.3780.100H	43,45,46,47,50
0008111807	20.5750.710.099	44
0008111907	20.5750.720.099	44
0008111933	40.2540.222H	42
0008112007	61.5750.100H	42
0008112033	40.2530.222H	44
0008112133	40.2530.222H	42
0008113333	40.2530.222H	42
0008113533	40.2540.222H	42
0008114033	15.5891.722.099	53,55,65
0008116433	40.2530.222H	42
0008118433	40.3680.222H	--
0008130436	14.5890.100.099	53,55,65
0008130536	14.5890.200.099	53,55,65
0008201277	08.5892.105.099	53,55,65
0008202713	09.5750.001.099	44
0008202813	09.5750.220.099	44
0008210129	10.3681.400	--
0008211229	10.3681.400	--
0018104414	58.3781.100H	46
0018104514	58.3781.200H	46
0018106016	15.2711.114	38,73
0018106116	15.2712.114	38,73
0018109016	61.3783.147H	46
0018109116	61.3783.167H	46
0018109216	61.3773.147H	43,46,50
0018109714	58.5752.100H	44
0018109814	58.5752.200H	44
0018109914	58.5752.300H	44
0018110022	13.5890.120.099	53,55,65
0018110122	13.5890.220.099	53,55,65
0018110433	15.3491.372H	51,63
0018110533	15.3491.371H	51,63
0018110633	15.3491.071H	51,63
0018110733	15.3491.072H	51,63

Vergleichsliste nach OE-Nummern Cross-reference-table

OE

Mercedes		
0028113333	19.1012.002.099	48
0028113433	19.1012.003.099	48
0028113733	19.1012.000.099	48
0028113833	19.1012.001.099	48
0028113933	15.5891.721.099	53,55,65
0028114633	19.5750.011.099	44
0028114733	19.5770.311.099	44
0028115233	19.5890.011.099	53,55,65
0028115333	19.5890.012.099	53,55,65
0028115633	19.5891.011.099	53,65
0028115733	19.5891.012.099	53,65
0028116333	15.6000.001.099	48
0028116433	15.6000.002.099	48
0028116533	15.6000.003.099	48
0028116633	15.6000.004.099	48
2818107116	51.2530.120H	42
3018102116	51.2530.140H	42
3148101316	51.2540.120H	42
3148101916	51.2540.130H	42
3148102016	51.2540.140H	42
3148102616	51.2530.140H	42
3568100611	20.2480.213	73,77
3600100512654	58.2704.048	79
3818102516	51.2530.120H	42
3818102616	51.2530.140H	42
3818107116	51.2530.120H	42
3818107316	51.2530.140H	42
6118100116	51.3490.110H	51
6228100116	59.3980.141	50
6288103016	59.3980.121	50
6288103116	59.3980.122	50
6288103316	59.3980.111	50
6288103416	59.3980.112	50
6288103616	59.3980.131	--
6288103716	59.3980.132	50
6298110033	15.3951.174	50
6298110133	15.3951.114	50
6298110233	15.3952.174	50
6338100216	59.3980.142	50
6418104216	51.3680.147H	--
6418104416	51.3680.167H	--
6418106816	51.3680.147H	--
6638100816	51.2530.120H	42
6718100095	20.2710.620	38,39,77
6718100716	59.3980.011H	50
6718100916	59.3980.021H	50
6718101316	59.3980.022H	50
6718101116	20.2480.210H	77
6738100816	51.2530.120H	42
6738103916	51.2540.120H	42
6738104016	51.2530.120H	42
6738104116	51.2540.140H	42
6738104216	51.2530.140H	42
86880001840	51.3640.127	--
86880320130	10.6321.100	26,27
86880410010	40.2500.222H	60
86880410290	10.6121.100	26,28
86880751690	08.2810.124	--
86880902140	11.2810.200H	--
86880902250	20.2810.310	50
87480181000	51.2510.127H	28
89199311514	08.3200.500	--
89199718444	40.2540.422H	42
8919978658	40.2540.422H	42
9018100116	51.3490.110H	51
9018100216	51.3490.120H	51
9018100916	51.3490.112H	51
9018101016	51.3490.122H	51
9018101093	56.3491.110H	51,63
9018101193	56.3492.110H	51,63
9018102516	59.3491.110H	51
9018102816	59.3491.120H	51
9018103716	59.3492.110H	51
9018103816	59.3492.120H	51
9018105716	51.3490.112H	51
9018105816	59.3491.110H	51
9018106116	59.3492.110H	51
9018106416	51.3490.120H	51
9018106616	51.3490.122H	51
9018106716	59.3491.120H	51
9018107016	59.3492.120H	51
9068101893	51.5891.111.199	52,64
9068101993	51.5891.211.199	52,64
9068102093	51.5891.411.199	52,64
9068102293	51.5892.111.199	52,64
9068102393	51.5892.211.199	52,64
9068102493	51.5892.411.199	52,64
9068102593	51.5892.311.199	52,64
9068102693	51.5893.111.199	52,64
9068102793	51.5893.211.199	52,64
9068103093	51.5891.112.199	--
9068103193	51.5891.212.199	--
9068103293	51.5891.412.199	--
9068103393	51.5891.312.199	--
9068103493	51.5892.112.199	--
9068103593	51.5892.212.199	--
9068103693	51.5892.412.199	--

OE

Mercedes		
9068103793	51.5892.312.199	--
9068103893	51.5893.112.199	--
9068103993	51.5893.212.199	--
9068104293	51.5891.114.199	--
9068104393	51.5891.214.199	--
9068104493	51.5891.414.199	--
9068104593	51.5891.314.199	--
9068104816	51.5891.111.199	52,64
9068104916	51.5891.211.199	52,64
9068105016	51.5891.411.199	52,64
9068105116	51.5891.311.199	52,64
9068105216	51.5892.111.199	52,64
9068105316	51.5892.211.199	52,64
9068105416	51.5892.411.199	52,64
9068105516	51.5892.311.199	52,64
9068105616	51.5893.111.199	52,64
9068105716	51.5893.211.199	52,64
9068106016	51.5891.113.199	52,64
9068106116	51.5891.213.199	52,64
9068106216	51.5891.413.199	52,64
9068106316	51.5891.313.199	52,64
9068106393	51.5894.410.199	52,64
9068106416	51.5892.113.199	52,64
9068106493	51.5894.310.199	52
9068106516	51.5892.213.199	52,64
9068106593	51.5894.112.199	--
9068106616	51.5892.413.199	52,64
9068106693	51.5894.212.199	--
9068106716	51.5892.313.199	52,64
9068106816	51.5893.113.199	52,64
9068106916	51.5893.213.199	52,64
9068107993	51.5895.412.199	--
9068108093	51.5895.312.199	--
9408105516	59.3964.210H	45
9418101016	59.3792.127H	--
9418102116	59.3792.127H	--
9418110007	20.3780.700H	46
9438104716	59.3965.210H	47
9738100314	58.3752.100	43
9738100414	58.3752.200	43
9738107316	59.3962.210H	45
0001590268	09.3200.320H	76
0008100102	51.5720.001.099	--
0008100211	20.2810.110H	--
0008100412	61.2703.110	79
0008100512	61.2703.120	79
0008100617	51.2500.127H	60
0008101613	11.3001.100	--
0008103716	51.2520.147H	60
0008105316	51.3200.147H	26
0008108316	51.3410.147H	26
0008110135	14.2530.100	--
0008110818	11.3491.200	--
0008110839	11.3491.300	--
0008114730	51.3209.197	--
0008114730	51.3490.282E	--
0008115330	51.3490.272E	--
0008115530	51.3490.182E	--
0008115730	51.3491.102.099	--
000811730	51.3491.101E	--
0008117733	40.3200.422H	26
0008119133	40.3665.118F	--
0008205198	10.6221.100	28,66,68
0008205198	10.6221.100	28,66,68
0008210929	10.6211.140	42
0018106116	15.2712.114	38,73
0018107216	51.3731.326	38,73
0018111433	40.2660.404H	27
0018210029	10.6221.100	28,66,68
0018271104	09.2810.220	--
0028104216	51.3770.001.002	--
0028106016	56.1004.001.099	45,47,48
0048204715	09.3200.360	--
3568100611	20.2480.213	73,77
3578110471	11.3730.210H	18,23,38,68,73
3818107216	51.2530.130H	--
4068105216	51.1522.211H	--
4168100416	51.1523.111H	--
6298100416	59.3951.300	--
6298110133	15.3951.114	50
9108100300	59.1039.125.099	54
9108100400	59.1039.225.099	54
9108100401	59.1039.525.099	55
9108100500	59.1039.175.099	54
9108100501	59.1039.625.099	55
9108100600	59.1039.275.099	54
9108100601	59.1039.575.099	55
9108100701	59.1039.675.099	55
9108100801	59.1039.501.099	55
9108100901	59.1039.601.099	55
9108101001	59.1039.551.099	55
9108101100	59.1039.104.099	54
9108101101	59.1039.651.099	55
9108101200	59.1039.204.099	54
9108101300	59.1039.154.099	--
9108101400	59.1039.254.099	54

OE

Mercedes		
9108101601	59.1039.701.099	55
9108101701	59.1039.801.099	55
9108101801	59.1039.751.099	55
9108101900	59.1039.105.099	55
9108101901	59.1039.851.099	54
9108102000	59.1039.205.099	54
9108102100	59.1039.155.099	54
9108102200	59.1039.255.099	54
9108107001	59.1039.558.099	55
9108107101	59.1039.658.099	55
9108108901	59.1039.101.099	54
9108109001	59.1039.201.099	54
9108109101	59.1039.151.099	54
9108109201	59.1039.251.099	54
9108109501	59.1039.158.099	54
9108109601	59.1039.258.099	54
9108112400	19.1039.412.099	54
9108112500	19.1039.411.099	54
9108112600	19.1039.012.099	54
9108112700	19.1039.011.099	54
9108112800	19.1039.812.099	54
9108112900	19.1039.811.099	54
9108113600	19.1039.312.099	54
9108113700	19.1039.311.099	54
9108113800	11.1039.012.099	54
9108113900	11.1039.011.099	54
9108114000	13.1039.002.099	54
9108114100	13.1039.001.099	54
9108114400	11.1039.002.099	54
9108114500	11.1039.001.099	54
9108250400	61.1039.002.099	54
9109064600	08.1039.002.099	54
9109064700	08.1039.001.099	54
9109065600	08.1039.011.099	54
9578110033	40.3605.204F	60
66560398	56.3492.110H	51,63
Miller		
545541	51.1009.009.001	--
Morelo		
205804	59.1018.007.099	72
205805	59.1018.008.099	72
205815	12.1018.001.099	72
205816	12.1018.002.099	72
205820	12.1018.005.099	72
205822	12.1018.009.001	72
205824	12.1018.010.001	72
205825	09.2910.005.099	72,75
205826	09.2910.002.099	72,75
Niesmann + Bischoff		
0866048	59.3601.128H	60
10222	59.3601.128H	60
12667	59.2761.302	--
21082	15.2780.841F	39,72,75
22922	59.1018.007.099	72
25032	19.1018.311.099	72
28852	12.1018.010.001	72
288523	12.1018.009.001	72
8002710	59.2761.302	--
8017159	59.2761.112	--
8020384-00	59.2780.230	39
8020385	59.2780.130	39
8034580	15.2780.841F	39,72,75
8034581 / 21082	15.2780.871F	39
8042965 / 23144	09.2910.005.099	72,75
8042972	59.1018.007.099	72
8042978 / 22922	59.1018.008.099	72
8049172	19.1018.311.099	72
8049173	19.1018.312.099	72
8061674 / 28852	12.1018.001.099	72
8061675 / 28852	12.1018.005.099	72
8061676	12.1018.010.001	72

Cross-reference-table Vergleichsliste nach OE-Nummern

OE			OE			OE		
Plaxton			Renault			Scania		
AA01978	20.2710.200H	38,73	7421326550	59.3900.223H	57	2599528	61.2910.010.002	--
AA01980	20.2480.213	73,77	7421326551	59.3901.223H	57	2599529	11.2910.014.000	--
AA-01980	20.2480.213	73,77	7421326554	59.3901.233H	56	2599530	11.2910.016.000	--
AA-01982	20.2710.111H	73	7421326558	59.3901.243H	--	2723896	59.2770.310.002	--
AA-01983	20.2710.121	73	7421346867	20.5520.250H	--	2728569	59.2710.211.099	40
AP064924B	59.2704.122	--	7421614025	09.3900.003.000	22,56,57,61	2729143	59.1041.001.099	41
AP064924B-3	20.2700.161	--	7421618499	08.5752.024.099	22,39,40,56,57,61	2729156	59.1042.003.099	41
AP064924B-4	20.2480.211H	77	7478493162	59.1025.003.099	--	2729158	59.1042.001.099	41
AP083895B-1	15.2712.113F	73	7482226023	59.5524.640.099	--	2739165	11.2770.102	40
AP105367C-3	15.3802.840H	23,68	7482226025	59.5524.648.099	22,57,61	2739167	15.2771.840	40
AP107424C-10	20.2480.217H	38,50,73,77	7482226027	59.5524.649.099	57	2739168	15.2771.870	40
AP107424C-4	51.3636.206	23,68	7482265705	59.5524.748.099	--	2760509	59.2910.012.001	74
AP119170C-10	11.2910.003.000	75	7484531138	59.1025.001.099	21,58,62	2794079	08.2910.001.002	40,75
AP119170C100	59.2910.003.001	74	7484531168	59.1025.002.099	21,58,62	2911918	09.1041.002.099	41
AP119170C-100	59.2910.003.001	74	7485120820	61.3900.120H	22,56,57,61	2926677	15.2780.870	39
AP119170C-11	11.2910.006.000	75				3070159	51.3000.002.001	67
AP119170C-12	11.2910.008.000	75	Scania			3070160	61.3000.004.001	67
AP119170C-13	11.2910.002.000	75	102088 / 2081428	55.3000.117	--	437489	51.2540.148	--
AP119170C-14	61.2910.011.002	--	108832	11.3001.100	--	437491	58.2481.012	--
AP119170C-15	11.2910.007.000	75	129429	20.2700.200H	38,73	639093	14.2530.100	--
AP119170C-16	61.2910.012.002	--	1441529	59.2706.121	--	639141	61.2530.110H	42
AP119170C-17	11.2910.011.002	75	1441530	59.2706.101	--	9006839	05.3308.100	--
AP119170C-18	11.2910.012.002	75	1441533	59.2706.124	--	SIAC		
AP119170C-2	59.2910.010.001	74	1441534	59.2706.104H	--	166351394	40.1009.004.099	69
AP119170C-5	61.2910.009.002	--	1448217	20.2480.210H	77	166352077	40.1009.002.099	69
AP119170C-6	61.2910.019.002	--	1451226	20.2480.216H	38,50,73,77	166428555 - ALT	51.1009.048.099	--
AP119170C-7	19.2910.001.099	41,75	1451227	20.2480.211H	77	447419568	55.2021.177	--
AP119170C-9	11.2910.001.000	75	1485117	59.2706.203	--	620031733 - ALT	59.1017.003.099	70
AP138271C-1	11.2780.510	--	1485118	59.2706.232	--	620031734 - ALT	59.1017.004.099	70
AP138271C-2	11.2780.910	39	1505201	15.3731.470H	18,38,73	620102328 - ALT	51.1009.017.099	69
AP138271C-3	15.2780.870	39	1505202	11.3730.210H	18,23,38,68,73	SIAC		
AP138274C	59.2780.180.001	39	1505203	61.2708.842H	79	620102331 - ALT	51.1009.113.001	--
AP138274C-1	11.2780.520	--	1522365	21.2706.100	--	620102332 - ALT	51.1009.009.099	69
AP140857C-1	59.2910.009.001	74	1522366	21.2706.110	--	620120281 - ALT	58.1017.005.099	70
AP140857C-3	61.2910.005.001	75	1522367	09.3200.360	--	620120282 - ALT	58.1017.006.099	70
AP140857C-4	61.2910.006.001	75	1527773	59.5581.100H	59	620120283 - ALT	58.1017.011.099	70
APAA-01976-4	11.3730.210H	18,23,38,68,73	1543451	51.2510.127H	28	620120284 - ALT	58.1017.012.099	70
APAA-01976-6	09.3200.360	--	1742422	09.3200.310H	15.27,73	620186052	09.3200.420H	26,69,71
APAA-01983-3	20.2710.500	--	1763444	51.1524.117	--	SOLARIS		
P105367C15	20.2480.210H	77	1767265	15.4001.740H	59	0000-059-207	11.2770.102	40
P107424C10	20.2480.216H	38,50,73,77	1805203	51.3732.326	38,73	0000-059-214	11.2770.202	40
P119170C-3	61.2910.003.001	75	1857128	59.2706.302	--	0000-059-216	11.2770.302	40
P119170C-4	61.2910.004.001	75	1880287	20.2710.121	73	0000-059-218	11.2770.402	40
P119170C8	15.2780.840	39,41,75	1880288	20.2710.111H	73	0000-059-220	11.2770.920	40
PAA01976-1	51.3731.326	38,73	1880289	59.2715.101.099	--	0000-059-224	61.2770.210	40
PAA019762	15.3731.470H	18,38,73	1880290	59.2715.102	--	0000-059-226	61.2770.211	40
PAA019763	15.2711.114	38,73	1880295	20.2710.200H	38,73	0000-059-281	15.2780.840	39,41,75
PAA019771	51.3732.326	38,73	1886454	40.2510.222H	28	0000-059-284	15.2780.870	39
PAA019774	15.2712.114	38,73	1893487	51.3635.206	23,68	0000-059-305	11.2780.910	39
PAA-01985	09.3200.220	76	1893489	15.3802.840H	38,73	0000-077-177	09.3200.320H	76
			1893532	51.3731.326	23,68	0000-083-525	55.2561.110	--
			1895048	51.3732.326	38,73	0000-153-082	11.2770.620	--
			1915758	20.2700.260	--	0000-156-745	15.2771.840	40
5001856290	61.3481.149H	19,58	1946640	15.2712.113F	73	0000-156-750	15.2771.870	40
5010578503	59.3900.123H	57	2081428	55.3000.108H	--	0000-162-850	40.2660.404H	27
5010578504	59.3900.223H	57	2092223	55.2462.117	--	0000-183-182	59.2706.002.001	--
5010578505	59.3901.123H	57	2092593	08.5752.024.099	22,39,40,56,57,61	0000-183-225	59.2706.001.001	--
5010578506	59.3901.223H	57	2116845	19.1019.013.099	59	0000-184-272 /		
5010578511	59.5580.247H	22,56,57,61	2116846	19.1019.014.099	59	4800-000-541	20.2710.630	--
5010623057	20.3900.510H	22,56,57,61	2116847	19.1019.313.099	59	0000-217-083	58.2704.048	79
5010623058	20.3900.520H	22,56,57,61	2116848	19.1019.314.099	59	0000-217-090	20.2480.211H	77
5010623231	59.3900.143H	22,56,61	2127721	55.2561.111.001	--	0000-268-353	51.2461.117H	--
5010623232	59.3900.243H	22,56,61	2127722	55.2706.005.001	--	0000-291-449	15.2561.640	--
5010623246	59.3900.133H	22,56,61	2239699	11.2770.920	40	000-375-081	20.2700.260	--
5010623247	59.3900.233H	22,56,61	22479890	56.2660.002.099	27	0004-002-358	58.2704.086	79
5010623689	59.3901.143H	56	2248592	58.2706.002.001	--	0004-025-588	58.2704.059	--
5010623690	59.3901.243H	--	2252649	58.2706.104H	--	0004-029-166	59.2770.211.099	40
5010623698	59.3901.233H	56	2252652	09.3200.320H	76	0004-034-172	20.2710.620	38,39,77
7420849799	59.5524.748.099	--	2332206	59.1005.003.099	59	0004-105-260	15.2561.600	--
7420849835	59.5524.649.099	57	2382791	59.2770.210.099	59	0004-412-256	55.2561.010	--
7420849837	59.5524.648.099	22,57,61	2411114	55.2561.111.001	--	1905-499-00	09.3200.220	76
7420849852	59.5524.640.099	--	2434918	09.2910.002.099	72,75	1905-501-000	58.2704.065	--
7420850409	20.5520.250H	--	2530656	59.2910.004.001	74	1905-501-001	58.2704.090	--
7420862779	11.3900.200H	22,56,61	2530662	59.2910.001.001	74	1905-501-020	58.2704.059	--
7420862782	61.3900.100H	22,56,57,61	2530663	61.2910.009.002	--	1905-501-040	20.2710.720	--
7420862795	15.3900.840H	22,56,57,61	2537657	11.2910.003.000	75	190550200	51.3732.326	38,73
7420862800	11.3910.200H	22,56,61	2537709	11.2910.011.002	75	1905-502-001	59.2770.210.099	40
7420862809	61.3911.110H	22,56,61	2537712	11.2910.017.000	75	190550300	51.3731.326	38,73
7420862810	15.3911.871H	22,56,61	2537714	61.2910.012.002	--	1905-503-001	59.2780.120.099	39
7420862812	08.5752.024.099	22,39,40,56,57,61	2537717	11.2910.020.002	--	1905-503-100	20.2780.630	--
7420862813	61.3911.120H	22,56,61	2537719	11.2910.017.000	--	1905-504-000	56.2661.147	--
7420862815	15.3911.872H	22,56,61	2537720	61.2910.012.002	--	1905-505-000	11.3001.100	--
7420866665	61.3900.110H	22,56,57,61	2537722	11.2910.010.000	75	1905-506-010	58.2704.093	79
7420866672	08.5752.024.099	22,39,40,56,57,61	2537723	11.2910.006.000	75	1905-506-100	51.2530.148H	--
7420903714	11.3900.201H	56	2537726	11.2910.006.001	75	1905-508-000	58.2704.048	79
7420903722	58.3900.143H	--	2541253	11.2910.007.000	75	1905-508-001	58.2704.071	--
7420903723	58.3900.133H	--	2541254	19.2910.002.099	41,75	1905-509-000	58.2704.070	79
7420903727	58.3900.243H	--	2541255	15.2780.840	39,41,75	1905-509-025	58.2704.051H	79
7420903732	58.3900.233H	--	2541259	59.2782.120	--	1905-510-000	59.3652.167H	--
7420903736	11.3910.201H	56	2541260	59.2910.010.001	74	1905-511-000	59.2640.110H	--
7420903880	11.3900.100H	57	2541261	59.2910.017.001	74	1905-530-080	40.2530.422H	42
7420903881	11.3900.101H	57	2541262	09.3200.330	22,56,61	1905731470	15.3731.470H	18,38,73
7420913815	61.3900.120H	22,56,57,61	2548189	61.2910.019.002	--	1905770210	11.3730.210H	18,23,38,68,73
7421020285	51.5524.930H	22,57,61,67	2556182				11.3730.210H	18,23,38,68,73
7421164788	59.5524.730.099	--	2567224					
7421276373	61.3482.149H	19,58	2567225					
7421326526	59.3900.233H	22,56,61	2577310					
7421326527	59.3900.243H	22,56,61	2599501					

OE		
SOLARIS		
1970018000	20.2480.216H	38,50,73,77
1970-018-000	20.2480.216H	38,50,73,77
1970-019-000	20.2480.217H	38,50,73,77
5300-008-114	15.2561.600	--
5300-009-015	11.2780.510	--
Steyr		
16100770103	51.2890.117H	68
Tatra		
443332031000	40.3305.218	--
443332032	40.3302.418H	--
443332041000	51.3300.149	--
443332042000	59.3601.128H	60
443332051000	51.3635.206	23,68
443332052000	51.3636.206	23,68
443332058000	51.3635.216	--
443332059000	51.3636.216	--
443400151000	51.3300.147H	--
990115703000	15.3802.840H	23,68
990115704000	40.3605.203H	60
Temsa		
5053APA03Y	61.2910.004.001	75
5053APA0401Y	15.2780.840	39,41,75
5053APA0403Y	19.2910.001.099	41,75
5053APA04Y	59.2910.002.001	74
5053APA05Y	61.2910.003.001	75
5053APA06Y	59.2910.001.001	74
HD301144-02Y	19.2910.002.099	41,75
HD3011444Y	59.2910.004.001	74
HD301151	61.2910.006.001	75
Temsa		
HD301152	61.2910.005.001	75
MD301145Y	59.2910.010.001	74
Terex		
103724	51.1523.121H	--
105518	55.2020.171	--
27230912	59.5524.530H	67
48092012	15.3802.840H	23,68
5253100003	51.3640.127	--
5653634760	51.1523.111H	--
5653634770	51.1524.118	--
5653634775	51.2500.127H	60
5653634816	51.2500.147H	60
5653634822	51.2493.137H	--
5653634825	51.1009.017.099	69
5653634830	51.1009.089.099	--
5653634836	40.1009.001.000	69
5653634837	40.1009.002.000	69
VDL		
20510114	51.2530.148H	--
24012180000	51.2530.128H	--
282500087	55.2561.110	--
30014897	59.2770.210.099	40
30014898	59.2780.120.099	39
30016869	11.2780.910	39
30017252	15.2780.870	39
30017729	59.2710.402H	73
30017737	51.3732.326	38,73
30017741	15.3731.470H	18,38,73
30017752	11.3730.210H	18,23,38,68,73
30017839	55.2561.010	--
30017840	15.2561.640	--
30017844	15.2771.870	40
30017845	20.2780.630	--
30017846	15.2780.840	39,41,75
30017876	15.2780.840	39,41,75
30022423	51.3731.326	38,73
30032132	55.2561.110	--
30045213	11.2770.202	40
30045214	11.2770.302	40
30045215	11.2770.402	40
30102976	20.2710.630	--
30103263	11.2780.510	--
30103281	61.2770.210	40
30103282	61.2770.211	40
30103284	11.2780.920	39
30103285	11.2780.510	--
30103286	59.2780.150.001	39
30110912	09.2910.006.001	--
30120778	59.2712.111	38
30120779	59.2712.114	38
30120780	20.2480.222	--
30120781	20.2480.221	--
30121356	59.2910.024.001	--
30121358	59.2910.023.001	--
30121380	61.2910.027.001	--
30121381	61.2910.026.001	--
30127115	59.2706.006.001	--
30130954	51.3635.206	23,68
30130955	15.3802.840H	23,68
30130962	11.2910.001.000	75
30130963	11.2910.006.000	75
30130964	11.2910.003.000	75

OE		
VDL		
30130965	11.2910.008.000	75
30130967	11.2910.012.000	--
30130970	61.2910.009.002	--
30130971	61.2910.019.002	--
30130972	19.2910.001.099	41,75
30130975	61.2910.010.002	--
30130976	61.2910.020.002	--
30130977	11.2910.016.000	--
30130978	11.2910.017.000	--
30130979	11.2910.014.000	--
30130981	19.2910.002.099	41,75
30130982	61.2910.011.002	--
30130983	61.2910.012.002	--
30130985	11.2910.002.000	75
30130986	11.2910.007.000	75
30139755	59.2910.027.001	--
30162330	55.3000.117	--
30162331	61.3000.002.001	67
30172295	59.2760.007.001	--
30172762	11.2770.040	--
30172776	61.2770.900.099	40
30184984	61.2910.006.001	75
30184985	61.2910.005.001	75
30207377	59.2910.500.001	--
30218618	20.2760.140	--
30218619	20.2760.150	--
30218620	51.3636.206	23,68
30218738	09.2910.003.099	40,75
30218739	08.3950.001.099	40,75
30226914	12.1018.002.099	72
30226915	19.1018.314.000	--
30243430	12.1018.001.099	72
31041266	08.2910.001.002	40,75
53707213480217	20.2480.217H	38,50,73,77
60000269	58.2601.010	--
60000270	09.3200.320H	76
H28250077	51.2500.167H	--
HJ24013370	51.3850.147H	66
J24013361200	09.3200.320H	76
P758200126	59.2710.401H	73
P759001645	20.2480.216H	38,50,73,77
P759001646	20.2480.217H	38,50,73,77
Viseon		
44152400300	09.2910.002.099	72,75
44176040317	59.2910.001.001	74
44176040318	59.2910.002.001	74
44176040321	59.2910.003.001	74
44176040322	59.2910.004.001	74
Volvo		
22210899	58.2704.065	--
0331121	20.2710.121	73
1096643	59.3601.128H	60
1581550	51.2500.127H	60
1581599	40.2500.222H	60
1581602	40.2500.422H	60
1581616	51.2500.147H	60
1594411	51.2500.147H	60
1594412	51.2500.147H	60
1594415	40.2500.422H	60
1594902 / 1621353 /		
1195934 / 3090396	51.2520.147H	60
1599462	51.2520.127H	60
161 00 77 0005	51.3200.147H	26
16281990	51.1009.025.099	69
16315898	55.2020.177H	60
1697007	40.2520.422H	60
1697927	14.2530.100	--
1697928	61.2530.110H	42
17452496	51.1009017099	--
20207881	59.3900.143H	22,56,61
20515454	20.2480.223	77
20523873	59.2710.410	--
20523877	59.2710.409	--
20526284	09.3200.320H	76
20526353	56.2660.127H	27
20540638	20.2710.500	--
20548032	56.2660.147H	27
20548137	58.2600.010H	--
20564284	58.2704.086	79
20567670	15.2240.840H	62
20707812	59.5580.247H	22,58,61
20707874	59.3900.133H	22,56,61
20707881	59.3900.143H	22,56,61
20708110	20.3900.510H	22,56,57,61
20708230	20.3900.520H	22,56,57,61
20708303	59.3900.233H	22,56,61
20743983	59.3900.243H	22,56,61
20849837	59.5524.648.099	22,57,61
20854088	20.2480.211H	77
20854564	15.3702.470H	60
20854568	15.3712.410H	--
20854576	40.2520.422H	60
20854583	40.3605.204F	60
20862779	11.3900.200H	22,56,61
20862782	61.3900.100H	22,56,57,61

OE		
Volvo		
20862795	15.3900.840H	22,56,57,61
20862800	11.3910.200H	22,56,61
20862809	61.3911.110H	22,56,61
20862810	15.3911.871H	22,56,61
20862812	08.5752.024.099	22,39,40,56,57,61
20862813	61.3911.120H	22,56,61
20862815	15.3911.872H	22,56,61
20866665	61.3900.110H	22,56,57,61
20866672	08.5752.024.099	22,39,40,56,57,61
20903722	58.3900.143H	22,56,57,61
20903723	58.3900.133H	22,56,61
20903727	58.3900.143H	22,56,57,61
20903732	58.3900.233H	22,56,61
20925244	08.3200.233H	39,40,72,75,76
20970652	51.3850.197H	66
20970794	61.3000.002.001	67
21020285	51.5524.930H	22,57,61,67
21070768	15.2242.870H	--
21083501	56.2600.147H	26
21083541	09.2070.1040	26,28,42,60,68,76
21150393	55.2561.110	--
21203313	61.2910.178H	60
21310517	51.2480.150H	--
21314080	55.3000.117	--
21320365	15.2242.870H	--
21320383	15.2240.840H	62
21326526	59.3900.233H	22,56,61
21326527	59.3900.243H	22,56,61
21386593	15.2712.113F	73
21462625	58.2704.065	--
21475603	59.3900.233H	22,56,61
21614025	09.3900.003.000	22,56,57,61
21618499	08.5752.024.099	22,39,40,56,57,61
21879369	59.2910.001.001	74
21879404	59.2910.004.001	74
21885961 / 22117455	61.2910.002.001	75
21885962	61.2910.005.001	75
21885963	61.2910.006.001	75
21885964	61.2910.003.001	75
21885965	61.2910.008.001	75
21894545	59.2910.002.001	74
21922258	59.2910.005.001	74
22026461	20.2710.650	39
22026977	59.2910.008.001	74
22033845	12.1018.001.099	72
22033846	12.1018.002.099	72
22033847	15.2780.840	39,41,75
22033848	19.1018.314.000	--
22038103	09.2910.002.099	72,75
22038110	08.3950.001.099	40,75
22117132	11.2910.003.000	75
22117135	11.2910.011.002	75
22117164	61.2910.009.002	--
22117179	19.2910.001.099	41,75
22117189	15.2780.840	39,41,75
22117205	61.2910.011.002	--
22117208	11.2910.008.000	75
22117209	11.2910.012.002	75
22117212	61.2910.020.002	--
22117213	11.2910.017.000	--
22117218	19.2910.002.099	41,75
22117220	61.2910.012.002	--
22117238	11.2910.011.000	75
22117239	11.2910.002.000	75
22117241	08.2910.001.002	40,75
22117451	59.2910.001.001	74
22117457	61.2910.007.001	75
22183247	58.2704.090	--
22200233	11.2910.006.000	75
22200241	61.2910.019.002	--
22200250	61.2910.010.002	--
22200257	11.2910.016.000	--
22200281	11.2910.014.000	--
22200293	11.2910.007.000	75
22200340	61.2770.003.002	--
22200342	61.2770.004.002	--
22210095	58.2704.048	79
22210161	58.2704.059	--
22210206	58.2704.071	--
22210216	20.2480.221	--
22212132	58.2705.002	--
22212554	09.2910.003.099	40,75
22274292	59.2770.310.002	--
22274295	59.2780.120.099	39
22329661	15.2561.640	--
22342703 / 8350055851	20.2710.630	--
22360737	59.2910.015.001	74
22360738	59.2910.016.001	74
22366228	59.2910.500.001	--
22479675	11.2780.910	39
22479729	20.2780.630	--
22479736	11.2780.510	--
224798	15.2780.840	39,41,75
22479822	58.2704.070F	39
22479887	11.2770.102	40
22479899	11.2770.040	--
22479901	11.2770.520H	--

DAF

373	II [e1] 02★0423 II (E1) 010423		ABS	Ø 28 mm
------------	-----------------------------------	--	-----	---------

	Beschreibung description descrição descripziõe descripciön benáming popis omivcawie özellik leirats opis		OE
--	--	--	----

61.3730.324H		384 x 205 x 120	1425 104 ♦ 1610 186
15.3731.470H		369 x 190 x 42	1425 109 ♦ 1610 190
11.3730.210H		367 x 187 x 60	1425 113

61.3730.326H		384 x 205 x 120	1425 105 ♦ 1610 184
15.3731.470H		369 x 190 x 42	1425 109 ♦ 1610 190
11.3730.210H		367 x 187 x 60	1425 113

386 386-1	IV [e1] 02★0424 IV (E1) 010424 IV [e1] 03★0023		ABS	Ø 28 mm
----------------------------	--	--	-----	---------

	Beschreibung description descrição descripziõe descripciön benáming popis omivcawie özellik leirats opis		OE
--	--	--	----

61.3860.214H		219 x 170 x 120	1425 108 ♦ 1610 187
15.3861.114H		203 x 154 x 36	1425 111 ♦ 1610 191
11.3860.500H		203 x 154 x 60	1425 114

61.3865.124H		219 x 170 x 120	1610 189
15.3862.174H		203 x 154 x 36	1610 182
11.3860.500H		203 x 154 x 60	1425 114

906	IV [e1] 03★0014		ABS	Ø 28 mm
------------	-----------------	--	-----	---------

	Beschreibung description descrição descripziõe descripciön benáming popis omivcawie özellik leirats opis		OE
--	--	--	----

61.9065.114H		209 x 218 x 136	1670 877
15.9060.870H		204 x 195 x 58	1670 878
11.9060.100H		202 x 194 x 55	1670 888

56.9065.110		209 x 218 x 136	
15.9060.870H		204 x 195 x 58	1670 878
11.9060.100H		202 x 194 x 55	1670 888
61.3860.100		210 x 9ø	

65 CF, 75 CF,
85 CF, 95 XF
alternativ 75 / 85 / 95

03/00 - 04/06
09/92



DAF

348	II 03★0184 II 021022		Ø 22 mm
	Beschreibung description description description benamning popis õireilikk leirás opis		OE
61.3481.149H	1	395 x 205 x 145	1805 714
15.3480.840H		372 x 189 x 32	1805 717
11.3480.100		169 x 88 x 27	
61.3480.149H	2	382 x 193 x 85	1405 295 * 1805 712 1404 871
40.3485.412H		375 x 190 x 3	1805 713

LF 45/55



348	IV 03★0185 IV 021023		Ø 22 mm
	Beschreibung description description description benamning popis õireilikk leirás opis		OE
61.3482.149H		199 x 199 x 97	1796 324 * 1404 868 1405 350
40.3485.403H		191 x 191 x 3	1796 325 * 1404 849



XF 95, XF 105, XF 106
CF 65/75/85
JOHN DEERE
01/06
05/06
10/11



XF 95, XF 105, XF 106
02/13



DAF

570	II e1 03★0007 II E1 02 1251			Ø 40 mm
	Beschreibung description descripção descripziōne benamning popis omrčavne čísliclik leirrás opis		OE	
61.5700.210H		411 x 228 x 140	1692 557	
61.5700.310.099		411 x 228 x 140	1812 862 + 1689 348	
15.5701.840H		363 x 177 x 25	1685 330 AL 20 31 51 (John Deere)	
11.5700.100H		411 x 228 x 110	1644 325	
09.5700.001.099		250 x 6 ø		

571 574	IV e1 03★0008 IV E1 02 1252 IV E1 02 1253			Ø 40 mm
	Beschreibung description descripção descripziōne benamning popis omrčavne čísliclik leirrás opis		OE	
EURO 5				
61.5710.210H		239 x 221 x 140	1692 556	
61.5710.310.099		239 x 221 x 140	1817 860 + 1689 347	
15.5711.870H		207 x 161 x 35	1685 331	
11.5710.110H		239 x 221 x 118	1644 326 + 1659249	
09.5700.002.099		250 x 6 ø	1812 865	
EURO 6				
61.5710.310.099		239 x 221 x 140	1817 860 + 1689 347	
15.5711.870H		207 x 161 x 35	1685 331	
11.5710.110H		239 x 221 x 118	1644 326 + 1659249	
61.5740.001.099		245 x 243 x 140	1940 341	
19.5740.311.099		211 x 192 x 40	1940 342	
12.5740.002.099		245 x 240 x 118	1882 113	

570 A			Ø 40 mm
	Beschreibung description descripção descripziōne benamning popis omrčavne čísliclik leirrás opis		OE
EURO 5			
XF			
58.5701.104.099		818 x 40 ø	1685 324 + 1812 867
58.5700.001.099		818 x 40 ø	1685 325 + 1830 562
EURO 6			
58.5700.003.002		818 x 40 ø	1940334
58.5700.004.002		818 x 40 ø	1940335
CF			
58.5713.114.099		920 x 40 ø	1788 972 + 1812 859
58.5710.001.099		920 x 40 ø	1788 487 + 1818 353
20.5700.410H		145 x 98 x 68	1644 324
20.5700.420H		145 x 98 x 68	1644 323

DAF

552 552-1	V 02★0742 V VI 03★0033 V VI 020894		
----------------------------	---	--	--

	Beschreibung description description descrição descripção benamining popis описаније özellik leirás opis		OE
59.5520.230H		319 x 187 x 50	1669 573
59.5520.240H		319 x 187 x 50	1614 022
59.5520.130H		319 x 187 x 50	

1005	V 04★1336 V 041336		
-------------	-------------------------	--	--

	Beschreibung description description descrição descripção benamining popis описаније özellik leirás opis		OE
59.1005.001.099		326 x 202 x 214	1949 304
59.1005.002.099		326 x 202 x 214	1949 305

1025	V 04★1345		
-------------	------------	--	--

	Beschreibung description description descrição descripção benamining popis описаније özellik leirás opis		OE
59.1025.001.099		315 x 179 x 220	1709 390
59.1025.002.099		315 x 179 x 220	1709 389

559	VI 021039 VI 03★0196		INTEGR.
------------	---------------------------	--	---------

	Beschreibung description description descrição descripção benamining popis описаније özellik leirás opis		OE
59.5595.235H		411 x 375 x 285	1684 042 ♦ 1816 912
59.5595.236		411 x 375 x 285	1684 043 ♦ 1816 913
59.5595.331H		1007 x 320 x 220	1684 046 ♦ 1816 914
59.5595.332		1007 x 320 x 220	1684 047 ♦ 1816 915
59.5595.131H		437 x 433 x 383	1684 030 ♦ 1816 902
59.5595.132H		437 x 433 x 383	1684 031 ♦ 1816 903
59.5595.135		471 x 437 x 300	1684 034 ♦ 1816 906
59.5595.136		471 x 437 x 300	1684 035 ♦ 1816 907
59.5595.134		437 x 383 x 323	1684 033 ♦ 1816 905
61.5590.001.099		256 x 165 x 82	1830 338
20.5521.100H		110 x 53 x 51	1698 180

XF 95, XF 105, XF 106
CF 65/75/85
01/06
05/06
DAF



New Regulation ECE R46/04



LF 45/55
New Regulation ECE R46/04



DAF

XF/XG/XG+
New Generation

10/2020



1027	NEW	II (E1) 041619 IV (E1) 041620			INTEGR.
-------------	------------	----------------------------------	--	--	----------------

	Beschreibung description description descripção descripzione beschrijving opis opisicaune druslik reigas opis		mm	
--	---	--	----	--

LHD	59.1027.001.099		1014 x 397 x 200	2248 157	
	59.1027.002.099		1014 x 414 x 258	2248 158	
	RHD	59.1027.003.099		1014 x 414 x 258	2248 175
		59.1027.004.099		1014 x 397 x 200	2248 176
a	12.1027.005.099	für für pour main mirror ◀	1 701 x 248 x 154	2248 166	
	12.1027.107.099	für für pour main mirror ◀	2 701 x 248 x 154	2248 172	
	12.1027.207.099	für für pour main mirror ◀	3 701 x 248 x 154	2298 826	
	12.1027.006.099	für für pour main mirror ▶	4 701 x 248 x 154	2248 167	
	12.1027.108.099	für für pour main mirror ▶	5 701 x 248 x 154	2248 173	
	12.1027.208.099	für für pour main mirror ▶	6 701 x 248 x 154	2298 827	
b	12.1027.001.099	für für pour upper foot ◀	7 205 x 103 x 98	2248 164	
	12.1027.002.099	für für pour upper foot ▶	8 205 x 103 x 98	2248 165	
c	12.1027.103.099	für für pour lower foot ◀	9 266 x 177 x 114	2248 160	
	12.1027.203.099	für für pour lower foot ◀	10 266 x 177 x 114	2298 758	
	12.1027.104.099	für für pour lower foot ▶	11 266 x 177 x 114	2248 161	
	12.1027.204.099	für für pour lower foot ▶	12 266 x 177 x 114	2298 759	
d	19.1027.011.099	24 V 120V	13 384 x 200 x 42	2306 590	
	19.1027.012.099	24 V 120V	14 384 x 200 x 42	2306 591	
	19.1027.311.099	24 V 300V	15 209 x 210 x 52	2306 592	
	19.1027.312.099	24 V 300V	16 209 x 210 x 52	2306 593	
	12.1027.015.099	für für pour neck ◀	17 176 x 164 x 79	2248 168	
	12.1027.016.099	für für pour neck ▶	18 176 x 164 x 79	2248 169	
	61.1029.224.099	für für pour	19 130 x 125 x 50	2306 586	
	61.1024.224.099	für für pour	20 130 x 125 x 50	2306 587	

a



black 1 4 paintable 2 5 crystalwhite 3 6

b



black 7 8

c



paintable 9 11 crystalwhite 10 12

d

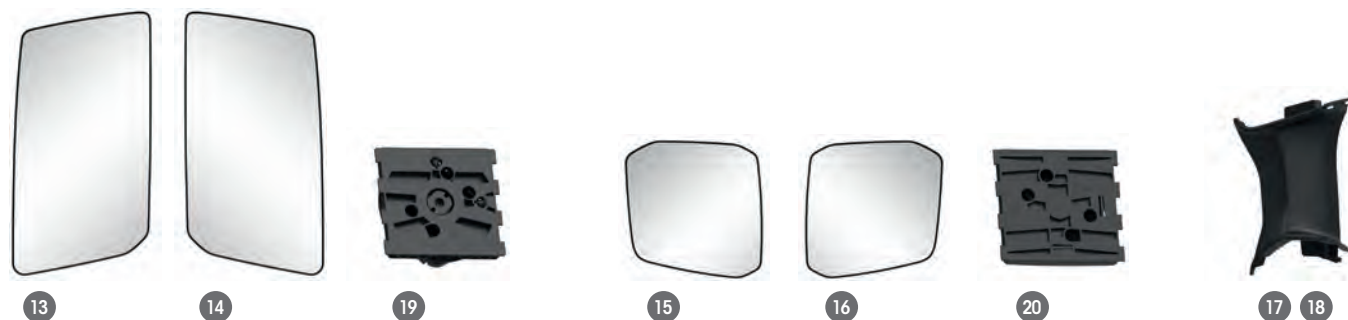

13 14 15 16 17 18 19 20

black

DAF

559	NEW	VI (E1) 021039			INTEGR.	
		VI (e1) 03★0196				
		Beschreibung description descripción descrizione beňnapišning popis optiskame detalik leiğäs opis		 mm		OE
59.5590.013.099		450 x 491 x 217		2248 178		
59.5590.014.099		450 x 491 x 217		2248 179		
12.5590.009.099		1	209 x 128 x 70	2248 184		

*XF / XG / XG+
New Generation*



10/2020

1005	NEW	V (e1) 04★1336				
		V (E) 041336				
		Beschreibung description descripción descrizione beňnapišning popis optiskame detalik leiğäs opis		 mm		OE
59.1005.011.099		330 x 233 x 205		2248 159		
12.1005.001.099		2	121 x 78 x 52	2248 174		

*XF / XG / XG+
New Generation*



IVECO

Stralis
Trakker
Eurocargo
Tector

04/06
04/06
04/06
04/06



1008		II e3 03★1034 IV e3 03★1036	Truck II+IV	ABS	INTEGR.
MEKRA LANG Group		Beschreibung description descripção descripziõe benamning Popis opis opis	mm	OE	
59.1008.005.099		24 V	799 x 370 x 272	504 150 526 + 504 369 910 580 133 4614	
59.1008.006.099		24 V	799 x 370 x 272	504 150 527 + 504 369 961 580 133 4610	
59.1008.045H*		24 V	799 x 370 x 272	504 150 532	
59.1008.046H*		24 V	799 x 370 x 272	504 150 533	
59.1008.011.099		24 V	799 x 424 x 287	504 150 538 + 504 370 048 580 133 6285	
59.1008.012.099		24 V	799 x 424 x 287	504 150 539 + 504 370 055 580 133 6298	
59.1008.051H*		24 V	799 x 424 x 287	504 150 544	
59.1008.052H*		24 V	799 x 424 x 287	504 150 545	
59.1008.017.099		24 V	811 x 520 x 304	504 150 551 + 504 369 979 580 134 1206	
59.1008.018.099		24 V	811 x 520 x 304	504 150 552 + 504 369 995 580 134 1207	
59.1008.057H*		24 V	811 x 520 x 304	504 150 557	
59.1008.058H*		24 V	811 x 520 x 304	504 150 558	
19.1008.041.099		24 V 1200	371 x 181 x 15	504 197 878	
19.1008.311.099		24 V 300	192 x 206 x 20	504 197 879	

* only available in UK/IRL



1008		V e3 03★1031	Truck V	ABS	
MEKRA LANG Group		Beschreibung description descripção descripziõe benamning Popis opis opis	mm	OE	
56.1008.001.099		300	270 x 230 x 60	504 168 235	
56.1008.002.099		300	270 x 230 x 60	504 168 236	
56.1008.003.099*		300	270 x 230 x 60	504 168 237	
56.1008.004.099*		300	270 x 230 x 60	504 168 238	
11.1008.001.099		fur for pour	210 x 205 x 100	504 168 244	

* only available in UK/IRL

IVECO

1008	VI e3 03★1042			INTEGR.
	Beschreibung description descripção descriptione benämning popis opis opis		OE	
55.1008.002.099		315 x 240 x 60	504 224 428	
55.1008.003.099*		315 x 240 x 60	504 224 429	
55.1008.004.099*		315 x 240 x 60	504 224 430	

* only available in UK/IRL

Stralis
Trakker
Eurocargo
Tector



04/06 - 2019
04/06
04/06
04/06

IVECO

279	NEW			INTEGR.
	Beschreibung description descripção descriptione benämning popis opis opis		OE	
19.2790.011.099		399 x 222	500 086 749	
19.2790.012.099		399 x 222	500 086 750	
19.2790.031.099		223 x 218	500 086 753	
19.2790.032.099		223 x 218	500 086 754	
11.2790.001.099		640 x 240 x 108	580 249 8968	
11.2790.002.099		640 x 240 x 108	580 249 8969	

S-Way, T-Way



2020

MAN

M 90, F 90

03/00



320	II [e1] 02★14054 II [e1] 02★14053 II (E1) 0114053		Ø 18-30 mm
	Beschreibung description descripção descripziune benamning popis opis opis		mm OE
51.3200.147H		380 x 190 x 100	81.63730-6193
40.3200.422H		366 x 176 x 3	81.63733-0036
09.3200.420H		42 x 42 x 54 [2000]	88.25505-0024

M 90, F 90

08/88 - 09/94



340 341	II [e1] 02★14098 II (E1) 0114098		① Ø 14-20 mm ② Ø 20-30 mm
	Beschreibung description descripção descripziune benamning popis opis opis		mm OE
51.3410.127H		377 x 189 x 65	81.63730-6233 + 81.63730-6220
51.3412.120H		377 x 189 x 65	81.63730-6420
40.3640.222H		363 x 175 x 3	81.63733-0025 + 81.63733-0030 81.63733-0060
51.3410.147H		377 x 189 x 65	81.63730-6234 + 81.63730-6221 81.62730-6221
51.3410.140		377 x 189 x 65	
40.3640.422H		363 x 175 x 3	81.63733-0064 + 81.63733-6003 81.63730-0032 + 81.63730-6003 81.63730-6202 + 85.20000-9601
10.6121.100		340 x 159	
09.2000.301H		2000 x 9ø	83.25402-6010
51.3400.147H		377 x 189 x 65	88.63730-6041 + 85.63730-6015 81.63730-6016
40.3640.422H		363 x 175 x 3	81.63733-0064 + 81.63733-6003 81.63730-0032 + 81.63730-6003 81.63730-6202 + 85.20000-9601
09.3400.420		42 x 42 x 54 [2000]	

M 90, F 90

07/88



260	IV [e1] 02★11001		Ø 14-20 mm
	Beschreibung description descripção descripziune benamning popis opis opis		mm OE
56.2600.127H		205 x 158 x 70	81.63730-6206
40.2605.204H		190 x 143 x 3	81.63733-0042
56.2600.147H		205 x 158 x 70	
40.2605.204H		190 x 143 x 3	81.63733-0042
10.6321.100		186 x 130	
09.2070.101H		2070 x 9ø	81.25432-0149

MAN

266 266-1	IV V 02★11008 IV V 0111008 IV V 0211008	 	① Ø 14-20 mm ② Ø 20-30 mm
----------------------------	--	------	------------------------------

		Beschreibung description descripção descrizione benamning popis описание özellik leirás opis		mm		OE	
56.2660.127H		①	214 x 164 x 55	81.63730-6235	+	81.63730-6222	
56.2662.120H		②	214 x 164 x 55	81.63730-6421			
40.2665.204H			200 x 150 x 3	81.63733-0061			
56.2660.147H		①	214 x 164 x 55	81.63730-6236	+	81.63730-6223	
40.2660.404H			200 x 150 x 3	81.63733-6007			
10.6321.100			186 x 130				
09.2000.301H			2000 x 9ø	83.25402-6010			
56.2660.001.099		①	214 x 164 x 60				
56.2660.004.099		①	214 x 164 x 60				
40.2665.203H			200 x 150 x 3				
56.2660.002.099		②	214 x 164 x 60	81.63730-6754			
40.2665.403H			200 x 150 x 3				
10.6321.100			186 x 130				
09.2000.301H			2000 x 9ø	83.25402-6010			

265	V 02★12007 V 0112007	 	① Ø 10 mm ②
------------	---------------------------	------	----------------

		Beschreibung description descripção descrizione benamning popis описание özellik leirás opis		mm		OE	
56.2650.121H		①	247 x 157 x 63	81.63730-6224			
59.2652.110H		②	247 x 157 x 63	81.63730-6237			

365-1	V VI 03★0015 V VI 020922 V VI 02★12015 V VI 0112015	 	
--------------	--	----------	--

		Beschreibung description descripção descrizione benamning popis описание özellik leirás opis		mm		OE	
59.3652.128H			324 x 184 x 98	82.63730-6033	+	81.63730-6294	
15.3946.670F			324 x 184 x 61	81.63733-0099			
59.3652.148H			324 x 184 x 98	82.63730-6034			
59.3652.168H			324 x 184 x 85	82.63730-6035			

08/88 - 09/94

M 90, F 90



MAN

M 90, F 90
G 90



08/88 - 09/94
09/87 - 05/95

08/88 - 09/94
09/87 - 05/95

M 90, F 90
G 90
F 2000, L 2000
M 2000
TG-L, TG-M



MAN / VW G 90 (6-9 t) 10/75 - 07/88



MAN

251	II e1 01★14050	Truck II	ABS	Ø 14-20 mm	
MEKRA LANG Group		Beschreibung description descripción descripção descripzione benámining popsis описанье özellik leirás opis		mm	OE
51.2510.127H		318 x 186 x 26	81.63730-6167 + 81.63730-6127		
40.2510.222H		308 x 176 x 3	81.63733-0032		
51.2510.137H		318 x 186 x 26			
40.2510.322H		308 x 176 x 3			
10.6211.100		282 x 162			
09.2070.101H		2070 x 9ø	81.25432-0149		
51.2510.147H		318 x 186 x 26	81.63730-6128 + 81.63730-6148		
40.2510.422H		308 x 176 x 3			
10.6221.100		282 x 162			
09.2070.101H		2070 x 9ø	81.25432-0149		

10/75 - 07/88

F8, F9



364	II e1 02★14082 II (E1) 0114082	Truck II	ABS	Ø 14-20 mm	
MEKRA LANG Group		Beschreibung description descripción descripção descripzione benámining popsis описанье özellik leirás opis		mm	OE
51.3640.127H		376 x 187 x 28	81.63730-6108 + 81.63730-6126 81.63730-6149 + 81.63730-6147 81.63730-6148 + 81.63730-6194		
40.3640.222H		363 x 175 x 3	81.63733-0025 + 81.63733-0030 81.63733-0060		
51.3640.137H		376 x 187 x 28			
40.3640.322H		363 x 175 x 3			
10.6111.100		340 x 159			
09.2070.101H		2070 x 9ø	81.25432-0149		
51.3640.147H		376 x 187 x 28	81.63730-6151 + 81.63730-6001		
40.3640.422H		363 x 175 x 3	81.63733-0064 + 81.63733-6003 81.63730-0032 + 81.63730-6003 81.63730-6202 + 85.20000-9601		
10.6121.100		340 x 159			
09.2070.101H		2070 x 9ø	81.25432-0149		

MAN

572	II e1 03★0031		ABS	Ø (18) / 22 / 28 mm
	II (E1) 020918			
	Beschreibung description descripção descrizione benamning Popis описанье özellik leirás opis		OE	
51.5720.120H		426 x 200 x 135	85.63730-6030	
40.5725.212H		412 x 188 x 3	81.63733-0101	
51.5720.140H		426 x 200 x 135	85.63730-6033	
40.5725.412H		412 x 188 x 3	81.63733-0103	
51.5721.160H		426 x 200 x 135	85.63730-6035	
51.5722.160H		426 x 200 x 135	85.63730-6036	
40.5725.412H		412 x 188 x 3	81.63733-0103	
61.5721.004.099		78 x 69 x 38		
11.5721.001.099		426 x 199 x 36		
11.3860.700		100 x 22 Ø → 18 Ø		

06/2005 →
06/2005 →

TGL, TGM (TGA)
L 2000, M 2000



MAN

573	IV e1 03★0032		ABS	Ø (18) / 22 / 28 mm
	IV (E1) 020917			
	Beschreibung description descripção descrizione benamning Popis описанье özellik leirás opis		OE	
56.5730.120H		202 x 198 x 126	85.63730-6037	
40.5735.203H		190 x 184 x 3	81.63733-0104	
56.5730.140H		202 x 198 x 126	85.63730-6039	
40.5735.403H		190 x 184 x 3	81.63733-0106	
61.5721.004.099		78 x 69 x 38		
11.5731.001.099		202 x 198 x 27		
11.3860.700		100 x 22 Ø → 18 Ø		





















579	V e1 03★0109		ABS	
	V (E1) 021179			
	Beschreibung description descripção descrizione benamning Popis описанье özellik leirás opis		OE	
56.5790.003.099		303 x 163 x 88	81.63730-6734* 81.63730-6574	
15.5791.570.099		303 x 163 x 55	81.63733-6078	
56.5790.004.099		303 x 163 x 88	81.63730-6733* 81.63730-6573	
15.5791.470H		303 x 163 x 55	81.63733-6074	















F 2000, L 2000
M 2000

09/94 - 03/00
09/97 - 03/00

MAN













373	II  02★0524 II  010524	 	Ø (18) / 22 mm
	Beschreibung description descripción descricao benamning popis omkažavie úzeľník leiras opis		OE
51.3735.121H		384 x 205 x 120	81.63730-6314 * 81.63730-6331
51.3736.121H		384 x 205 x 120	81.63730-6303 * 81.63730-6332
51.3735.124H		384 x 205 x 120	81.63730-6315 * 81.63730-6365 81.63730-6361
51.3736.124H		384 x 205 x 120	81.63730-6304 * 81.63730-6366 81.63730-6362 * 81.63732-0046
51.3731.325		384 x 205 x 120	
51.3732.325		384 x 205 x 120	
51.3735.126H		384 x 205 x 120	81.63730-6316 * 81.63730-6367 81.63730-6363 * 81.63732-0051
51.3736.126H		384 x 205 x 120	81.63730-6305 * 81.63730-6368 81.63730-6364 * 81.63732-0047
15.3731.070H		369 x 190 x 42	81.63733-0066 * 81.63730-0066
15.3731.074H		369 x 190 x 42	81.63733-0067 * 81.63733-0075 81.63730-0067
11.3730.310H		367 x 187 x 60	
11.3860.700		100 x 22 ø -> 18 ø	















386	IV  02★0424 IV  010424	 	Ø (18) / 22 mm
	Beschreibung description descripción descricao benamning popis omkažavie úzeľník leiras opis		OE
56.3860.112H		219 x 170 x 120	81.63730-6306
56.3860.114H		219 x 170 x 120	81.63730-6307 * 81.63732-0050
56.3861.116H		219 x 170 x 120	81.63730-6317 * 81.63732-0049
56.3862.116H		219 x 170 x 120	81.63730-6308 * 81.63730-6328 81.63732-0048
11.3860.300H		203 x 154 x 60	
11.3860.700		100 x 22 ø -> 18 ø	



MAN

380-1	II  03★0022 II  020905	 	Ø (18) / 22 mm
	Beschreibung description descripção descrizione benamning Popis описання özellik leírás opis		OE
51.3801.148H		384 x 205 x 120	82.63730-6015
51.3802.148H		384 x 205 x 120	82.63730-6016
51.3801.168H		384 x 205 x 120	82.63730-6017
51.3802.168H		384 x 205 x 120	82.63730-6018
15.3802.840H		368 x 189 x 40	81.63733-0095
11.3800.300H		374 x 196 x 40	81.63732-0044
11.3860.700		100 x 22 ø -> 18 ø	

381-1	IV  03★0023 IV  021248	 	Ø (18) / 22 mm
	Beschreibung description descripção descrizione benamning Popis описання özellik leírás opis		OE
56.3812.128H		219 x 170 x 120	82.63730-6022 * 82.63730-6021
56.3812.148H		219 x 170 x 120	82.63730-6024 * 82.63730-6023
56.3811.168H		219 x 170 x 120	82.63730-6025
56.3812.168H		219 x 170 x 120	82.63730-6026
15.3811.870H		203 x 154 x 36	81.63733-0097 * 81.63733-0098
11.3810.340		209 x 160 x 40	81.63732-0078 * 81.63732-0045
11.3860.700		100 x 22 ø -> 18 ø	

New Regulation
F 2000, L 2000
M 2000
2003/97/ECE
2007/38/ECE
09/94 - 03/00
09/97 - 03/00



MAN

MAN

F2000
TGA
TGL
TGM

09/94 - 03/00
03/00 →
2005 - 11/14
04/06 - 11/14



579	V e1 03★0109			
	V (E1) 021179			
	Beschreibung description descriçãõ descripziõne descripciõn benamning popis omicaive üzellik leirás opis		mm	
56.5790.003.099		303 x 163 x 88	81.63730-6734 + 81.63730-6574	
15.5791.570.099		303 x 163 x 55	81.63733-6078	
56.5790.004.099		303 x 163 x 88	81.63730-6733* 81.63730-6573	
15.5791.470H		303 x 163 x 55	81.63733-6074	

TGA
TGL
TGM

03/00 - 11/06
2005 - 11/06
04/06 - 11/06



















392	II e1 02★0646			Ø 28 mm
	II (E1) 010646			
	Beschreibung description descriçãõ descripziõne descripciõn benamning popis omicaive üzellik leirás opis		mm	
51.3921.222H		399 x 207 x 137	81.63730-6395 + 81.63730-6345 81.63730-6430	
15.3921.870H		379 x 176 x 47	81.63733-0082 + 81.63733-6033	
51.3922.222H		399 x 222 x 138	81.63730-6399 + 81.63730-6347 81.63730-6432	
15.3922.870H		379 x 176 x 47	81.63733-0083 + 81.63733-6034	
11.3920.300H		57 x 23 x 30	81.63731-0286	
04.0603.004		30 x 6 Ø		
11.3921.110H		399 x 196 x 52	81.63732-0054 + 81.63732-0059 81.63732-0063	
11.3921.120H		399 x 210 x 52	81.63732-0055 + 81.63732-0060 81.63732-0064	



393	IV e1 02★0647			Ø 28 mm
	IV (E1) 010647			
	Beschreibung description descriçãõ descripziõne descripciõn benamning popis omicaive üzellik leirás opis		mm	
56.3931.222H		188 x 207 x 129	81.63730-6409 + 81.63730-6351 81.63730-6443	
15.3931.870H		177 x 167 x 38	81.63733-0085 + 81.63733-6037	
56.3932.222H		188 x 220 x 130	81.63730-6410 + 81.63730-6350 81.63730-6444	
15.3931.870H		177 x 167 x 38	81.63733-0085 + 81.63733-6037	
11.3920.300H		57 x 23 x 30	81.63731-0286	
04.0603.004		30 x 6 Ø		
11.3931.110H		187 x 197 x 52	81.63732-0057 + 81.63732-0061 81.63732-0065	
11.3931.120H		187 x 209 x 52	81.63732-0056 + 81.63732-0062 81.63732-0066	

MAN

392-1	II e1 03★0024 II (E1) 02 0925	 	Ø 28 mm
--------------	----------------------------------	---	---------

MEKRA LANG Group		Beschreibung description descripção descrizione benamining popis opisaniye birelik leirás opis	mm	OE
51.3921.224H		399 x 207 x 137	81.63730-6482	
51.3923.224H		339 x 222 x 138	81.63730-6487	
51.3921.223H		399 x 207 x 137	81.63730-6480	
51.3923.223D		399 x 222 x 138	81.63730-6485	
15.3920.840H		379 x 176 x 47	81.63733-6049	
51.3922.224H		399 x 222 x 138	81.63730-6483	
51.3924.224H		399 x 207 x 137	81.63730-6486	
51.3922.223H		399 x 222 x 138	81.63730-6481	
51.3924.223D		399 x 207 x 137	81.63730-6484	
15.3920.840H		379 x 176 x 47	81.63733-6049	
11.3921.400		117 x 62 x 9	81.63731-0309 * 81.63731-0366	
04.0603.004		30 x 6 ø		
11.3921.110H		399 x 196 x 52	81.63732-0054 * 81.63732-0059 81.63732-0063	
11.3921.120H		399 x 210 x 52	81.63732-0055 * 81.63732-0060 81.63732-0064	

New Regulation
2003/97/ECE

12/06 →
12/06 - 11/14
12/06 - 11/14

TGA
TGL
TGM















New Regulation
2007/38/ECE

01/07 →
12/06 - 11/14
12/06 - 11/14

TGA
TGL
TGM



393-1	IV e1 03★0025 IV (E1) 02 0924	 	Ø 28 mm
--------------	----------------------------------	---	---------

MEKRA LANG Group		Beschreibung description descripção descrizione benamining popis opisaniye birelik leirás opis	mm	OE
56.3931.343H		188 x 207 x 129	81.63730-6510	
56.3931.323H		188 x 207 x 129	81.63730-6512	
15.3932.870H		177 x 167 x 38	81.63733-6057	
56.3932.343H		188 x 220 x 130	81.63730-6511	
56.3932.323H		188 x 220 x 130	81.63730-6513	
15.3932.870H		177 x 167 x 38	81.63733-6057	
11.3921.400		117 x 62 x 9	81.63731-0309 * 81.63731-0366	
04.0603.004		30 x 6 ø		
11.3931.110H		187 x 197 x 52	81.63732-0057 * 81.63732-0061 81.63732-0065	
11.3931.120H		187 x 209 x 52	81.63732-0056 * 81.63732-0062 81.63732-0066	

TGL Evolution
TGM Evolution
(Euro 6) 12/14
(Euro 6) 12/14

MAN

MAN



392-2		II [e1] 03★0024 II (E1) 02 0925	Truck II	ABS	Ø 28 mm
MEKRA LANG Group		Beschreibung description descripção descripziõe benámenning popis omicaawie özellik leirás opis	mm		OE
51.3920.002.099		399 x 210 x 120	81.63730-6738		
51.3920.004.099		399 x 225 x 121	81.63730-6745		
51.3920.001.099		399 x 210 x 120	81.63730-6739		
51.3920.014.099		399 x 225 x 121	81.63730-6746		
51.3920.003.099		399 x 225 x 121	81.63730-6740		
51.3920.005.099		399 x 210 x 120	81.63730-6743		
51.3920.013.099		399 x 225 x 121	81.63730-6741		
51.3920.012.099		399 x 210 x 120	81.63730-6744		
19.3920.011.099		379 x 176 x 34	81.63733-6079		
12.3920.001.099		399 x 203 x 52	81.63732-0094		
12.3920.002.099		399 x 208 x 53	81.63732-0095		
11.3921.400		117 x 62 x 9	81.63731-0309 + 81.63731-0366		
04.0603.004		30 x 6 ø			

393-2		IV [e1] 03★0025 IV (E1) 02 0924	Truck IV	ABS	Ø 28 mm
MEKRA LANG Group		Beschreibung description descripção descripziõe benámenning popis omicaawie özellik leirás opis	mm		OE
56.3930.004.099		187 x 210 x 127	81.63730-6748		
56.3930.002.099		187 x 210 x 127	81.63730-6749		
56.3930.003.099		188 x 223 x 128	81.63730-6750		
56.3930.001.099		188 x 223 x 128	81.63730-6751		
19.3930.311.099		177 x 167 x 35	81.63733-6080		
12.3930.001.099		187 x 197 x 52	81.63732-0096		
12.3930.002.099		187 x 209 x 52	81.63732-0097		
11.3921.400		117 x 62 x 9	81.63731-0309 + 81.63731-0366		
04.0603.004		30 x 6 ø			

579		V [e1] 03★0109 V (E1) 021179	Truck V	ABS	
MEKRA LANG Group		Beschreibung description descripção descripziõe benámenning popis omicaawie özellik leirás opis	mm		OE
56.5790.002.099		303 x 163 x 88	81.63730-6735 + 81.63730-6578		
15.5791.570.099		303 x 163 x 55	81.63733-6078		

MAN

580	II 03★0097			INTEGR.
	II 020929			
	IV 03★0098			
	IV 020930			

	Beschreibung description descripción descrizione beschreibung opis oírcaíne özetlik opís		OE

59.5800.101H		943 x 382 x 153	81.63730-6529	TGX
59.5800.102H		943 x 382 x 153	81.63730-6560 + 81.63730-6756	
59.5800.302H		943 x 382 x 153	81.63730-6563 + 81.63730-6767	
59.5800.201H		943 x 382 x 153	81.63730-6531	
59.5800.202H		943 x 382 x 153	81.63730-6561 + 81.63730-6765	
59.5800.203H		943 x 382 x 153	81.63730-6564 + 81.63730-6770	
59.5800.402H		943 x 382 x 153	81.63730-6562 + 81.63730-6758	

58.5800.101H		943 x 281 x 28 ø	81.63731-6638
58.5800.102H		943 x 281 x 28 ø	81.63731-6639

59.5800.121H		943 x 437 x 153	81.63730-6533	TGS
59.5800.122H		943 x 437 x 153	81.63730-6549 + 81.63730-6755	
59.5800.322H		943 x 437 x 153	81.63730-6552 + 81.63730-6764	
59.5800.221H		943 x 437 x 153	81.63730-6534	
59.5800.222H		943 x 437 x 153	81.63730-6550 + 81.63730-6762	
59.5800.223H		943 x 437 x 153	81.63730-6553 + 81.63730-6761	
59.5800.422H		943 x 437 x 153	81.63730-6551 + 81.63730-6757	

58.5800.201H		943 x 334 x 28 ø	81.63731-6640
58.5800.202H		943 x 334 x 28 ø	81.63731-6641

15.5801.840H		381 x 201 x 22	81.63733-6071	a
15.5811.871H		197 x 181 x 42	81.63733-6073	b
15.5811.872H		197 x 181 x 42	81.63733-6072	c

13.5800.100H		634 x 259 x 90	81.63732-0091
11.5800.100H		631 x 237 x 174	81.63731-0356
11.5800.200H		631 x 237 x 174	81.63731-0380

20.5800.410H		289 x 149 x 85	81.63732-0073
20.5800.420H		289 x 149 x 85	81.63732-0074
20.5800.610H		242 x 140 x 94	81.63732-0075
20.5800.620H		242 x 140 x 94	81.63732-0076
20.5800.710H		127 x 116 x 33	81.62410-0107
20.5800.720H		127 x 116 x 33	81.62410-0108
20.5800.750H		13 x 19 ø	81.63732-0090 + 81.62410-0109

579	V 03★0109			
	V 021179			

	Beschreibung description descripción descrizione beschreibung opis oírcaíne özetlik opís		OE

56.5790.002.099		303 x 163 x 88	81.63730-6735 + 81.63730-6578
15.5791.570.099		303 x 163 x 55	81.63733-6078

TGX / TGS
09/07 - 2021



TGX / TGS
01/2011



2020
2020
2020

TGX/TGS new
TGL new
TGM new

MAN



MAN

1024 **NEW** II (E1) 041543 IV (E1) 041542 **INTEGR.**

Beschreibung description descrição descrição descrição benámining popis omicaame бейлік lefrás optis mm

L H D	59.1024.001.099				kurz short			936 x 355 x 206	81.63730-6859	
	59.1024.002.099				kurz short			936 x 355 x 206	81.63730-6860	
	59.1024.005.099				lang long			936 x 455 x 288	81.63730-6875	
	59.1024.006.099				lang long			936 x 455 x 288	81.63730-6874	
	59.1024.009.099				kurz short			936 x 355 x 206	81.63730-6853	
	59.1024.010.099				kurz short			936 x 355 x 206	81.63730-6854	
	59.1024.013.099				lang long			936 x 455 x 288	81.63730-6869	
	59.1024.014.099				lang long			936 x 455 x 288	81.63730-6868	
	59.1024.017.099				kurz short			936 x 355 x 206	81.63730-6865	
	59.1024.019.099				lang long			936 x 455 x 206	81.63730-6878	
	R H D	59.1024.021.099				kurz short			936 x 355 x 206	81.63730-6863
		59.1024.022.099				lang long			936 x 455 x 288	81.63730-6879
		59.1024.023.099				kurz short			936 x 355 x 206	81.63730-6861
		59.1024.024.099				kurz short			936 x 355 x 206	81.63730-6862
		59.1024.025.099				lang long			936 x 455 x 288	81.63730-6877
		59.1024.026.099				lang long			936 x 455 x 288	81.63730-6876
		59.1024.027.099				kurz short			936 x 355 x 206	81.63730-6855
59.1024.028.099					kurz short			936 x 355 x 206	81.63730-6856	
59.1024.029.099					lang long			936 x 455 x 288	81.63730-6871	
59.1024.030.099					lang long			936 x 455 x 288	81.63730-6870	
19.1024.011.099								379 x 193 x 35	81.63733-6083	
19.1024.012.099							379 x 193 x 35	81.63733-6084		
19.1024.311.099							204 x 196 x 51	81.63733-6085		
19.1024.312.099							204 x 196 x 51	81.63733-6086		
13.1024.001.099							427 x 244 x 122	81.63732-0111		
13.1024.002.099							427 x 244 x 122	81.63732-0110		
13.1024.003.099				paintable			427 x 244 x 122	81.63732-0125		
13.1024.004.099				paintable			427 x 244 x 122	81.63732-0124		
12.1024.009.099				foot cover top			241 x 137 x 105	81.63732-0115		
12.1024.010.099				foot cover top			241 x 137 x 105	81.63732-0114		
12.1024.011.099				foot cover bottom			215 x 148 x 100	81.63732-0113		
12.1024.012.099				foot cover bottom			215 x 148 x 100	81.63732-0112		

MAN

1020	NEW	V (E1) 041389			INTEGR.
-------------	------------	---------------	--	--	---------

	Beschreibung description descripção descrizione benamning pops описанье özellik leirás opis		mm	OE
--	--	--	----	----

56.1020.017.099			LIN-BUS	307 x 279 x 95	81.63730-6845
56.1020.018.099			LIN-BUS	307 x 279 x 95	81.63730-6846
56.1020.019.099			CAN-BUS	307 x 279 x 95	81.63730-6844
56.1020.020.099				307 x 279 x 95	81.63730-6843
56.1020.015.099				307 x 279 x 95	81.63730-6881
19.1020.213.099				297 x 172 x 62	81.63733-6087
19.1020.613.099				297 x 172 x 62	81.63733-6088
12.1020.003.099				191 x 137 x 41	81.63732-0106

MAN TGX/TGS



MAN

2017

1013	NEW	II (E1) 041427			INTEGR.
-------------	------------	----------------	--	--	---------

	Beschreibung description descripção descrizione benamning pops описанье özellik leirás opis		mm	OE
--	--	--	----	----

19.1013.011.099				211 x 169 x 19	MAN 65.63733-0002 MAN 65.63733-0015
19.1013.012.099				211 x 169 x 19	MAN 65.63733-0006 MAN 65.63733-0014

TGE



MAN

2002
2002
09/2012

*Euroliner
Trendliner
PLAXTON: Elite*



*Intercity Mega S 2000
R07/08, A 20
Euroliner
Trendliner
Tourliner
Lions Coach Fortuna*

09/99
09/01
2002
2003



276	II [E1] 02★0524	II [E1] 02★ 0423			
	II [E] 010524	II [E] 010423			
	II [E1] 03★0022	II [E1] 03★0088			
	II [E] 020905	II [E] 020923			

	Beschreibung description description descripção descripção benämning pops omicaame üzeylik letras opis		mm	

1	59.2762.101		592 x 205 x 120	
	51.3732.326		384 x 205 x 116	81.63730-6374 + 81.63730-6390
	15.3731.470H		369 x 190 x 42	81.63733-6029 + 81.63733-0075
	11.3730.210H		367 x 187 x 60	81.63732-0058
2	59.2762.322		592 x 205 x 120	
	51.3732.326		384 x 205 x 116	81.63730-6374 + 81.63730-6390
	15.3731.470H		369 x 190 x 42	81.63733-6029 + 81.63733-0075
	11.3730.210H		367 x 187 x 60	81.63732-0058
	59.2762.422		592 x 205 x 120	
	51.3731.326		384 x 205 x 116	81.63730-6375
	15.3731.470H		369 x 190 x 42	81.63733-6029 + 81.63733-0075
	11.3730.210H		367 x 187 x 60	81.63732-0058
	20.2710.620		124 x 59 x 21 [500]	36.63731-6000

271	II [E1] 02★0524			
	II [E1] 010524			

	Beschreibung description description descripção descripção benämning pops omicaame üzeylik letras opis		mm	

1	59.2712.111		783 x 703 x 212	83.63700-6502 + 81.63700-6091
	51.3731.326		384 x 205 x 116	81.63730-6375
	15.3731.470H		369 x 190 x 42	81.63733-6029 + 81.63733-0075
	15.2711.114		165 x 93 x 25	81.63733-6027
	11.3730.210H		367 x 187 x 60	81.63732-0058
	20.2700.200H		126 x 25 ø	
	20.2710.200H		183 x 181 x 84	81.63731-0289
	20.2480.216H		108 x 50 x 15 [2000]	83.63731-6507
2	59.2712.114		641 x 701 x 200	83.63700-6501 + 81.63700-6092
	51.3732.326		384 x 205 x 116	81.63730-6374 + 81.63730-6390
	15.3731.470H		369 x 190 x 42	81.63733-6029 + 81.63733-0075
	15.2711.114		165 x 93 x 25	81.63733-6027
	15.2712.114		152 x 128 x 23	81.63733-6028
	11.3730.210H		367 x 187 x 60	81.63732-0058
	20.2700.200H		126 x 25 ø	
	20.2710.200H		183 x 181 x 84	81.63731-0289
		20.2480.217H		108 x 50 x 15 [5000]

MAN

278

II 03★0128
 II 020951
 IV 03★0129
 IV 020952

Beschreibung
description
description
description
benamning
popis
özellik
leírás
opis

mm

59.2780.130						684 x 247 x 174		1
59.2780.120.099						684 x 247 x 174	88.63700-6059	
59.2780.230						684 x 247 x 174		
59.2781.120						684 x 247 x 174		
59.2780.200.001						684 x 247 x 174		
59.2780.140.001						684 x 247 x 174	83.63700-6510	2
59.2780.150.001						684 x 247 x 174	83.63700-6511	
59.2780.180.001						684 x 247 x 174		
59.2780.160.001						684 x 247 x 174		
59.2780.170.001						684 x 247 x 174		
20.2710.620						124 x 59 x 21 [500]		
20.2710.650						124 x 59 x 21 [3500]		
08.3200.233H						42 x 42 x 54	81.25525-0232	
15.2780.840						307 x 177 x 22	81.63733-0113	
15.2780.841F						307 x 177 x 22		
15.2780.870						177 x 177 x 34	81.63733-0112	
15.2780.871F						177 x 177 x 34		
11.2780.910						681 x 229 x 104	81.63732-0088	
11.2780.920						681 x 229 x 104	36.63732-0006	
08.5752.012						130 x 120 x 53		
08.5752.024.099						130 x 120 x 53		

MAN Lion's City
 MAN Lion's Regio
 MAN Lion's Star
 Inter Deck, IRISBUS (Citelis),
 KRAVTEX, LAZ, SOLARIS (Urbino),
 VDL (Citea), VOLVO 7900H,
 Heuliez, Caetano, Plaxton, Scania
 2007



1



2

MAN

MAN

277	II E1 03★0084 II E1 020915	Truck II	ABS	INTEGR.
------------	---	----------	-----	---------

MEKRA LANG Group	Beschreibung description description description description benamning pops omrcauwe örellek leiraks opis	mm	OE
---------------------	---	----	----

59.2770.210.099		1001 x 720 x 254	88.63700-6062
59.2770.211.099		1001 x 720 x 254	88.63700-6066
59.2771.210		1001 x 720 x 254	88.63700-6060
09.2770.210	(→ 59.2770.210.099)	6050 x 6 ø	88.25426-6837
09.2770.211 + 09.2770.210	(→ 59.2770.211.099)	6050 x 6 ø	33.25404-6190 + 88.25426-6837
09.2770.001.000	(→ 59.2771.210)	6050 x 6 ø	
08.2910.001.002	LED		33.25203-6001
09.2910.003.099	(for LED)	6050 x 6 ø	
08.3200.233H		42 x 42 x 54	81.25525-0232
08.2770.001.000		45 x 40 x 44	81.25505-6247
08.3950.001.099	Control Unit (→ 59.2771.210)	40 x 30 x 30	
15.2771.840		307 x 183 x 23	81.63733-0110
15.2771.870		206 x 166 x 37	81.63733-0111
61.2770.210		670 x 280 x 253	81.63730-0083
61.2772.211.099		670 x 280 x 253	
61.2770.211	(→ 59.2770.210 + 59.2770.211.099)	817 x 192 x 130	81.63731-0373
11.2770.920		669 x 254 x 237	81.63732-0087
11.2770.102	1	707 x 123 x 185	36.63732-0000
11.2770.202	2	399 x 149 x 129	36.63732-0002
11.2770.302	3	268 x 151 x 118	36.63732-0001
11.2770.402	4	399 x 153 x 128	36.63732-0003
61.2772.100	(for LED)	399 x 172 x 129	81.63732-0089
08.5752.024.099		130 x 120 x 53	81.63734-6001
61.2770.900.099	KIT 1		36.63732-6000
61.2770.901.099	KIT 2		

MAN Lion's City
 MAN Lion's Regio
 MAN Lion's Star
 IRISBUS (Citelis), KRAVTEX, LAZ,
 SOLARIS (Urbino),
 VDL (Citea), VOLVO 7900H,
 Heuliez, Caetano, Plaxton, Scania
 2007



KIT 1



Scharnierdeckel Hinge cover Scharnierklemme Hinge clamp Schenkelfeder Spring screw

KIT 2

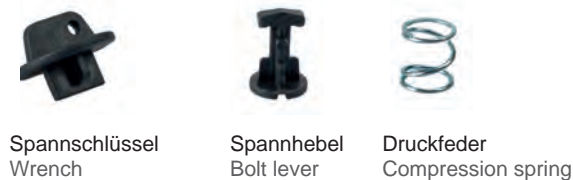

Spann Schlüssel Wrench Spannhebel Bolt lever Druckfeder Compression spring

MAN

1041		II (E1) 041480		Truck II	ASA	INTEGR.
MEKRA LANG Group		Beschreibung description description description benämning popis onivcaune bűellik leirás opis		mm		OE
59.1041.001.099		636 x 907 x 250	36.63700-6018			
59.1041.002.099		636 x 907 x 250	33.63700-6004			
15.2780.840		178 x 307 x 22	36.63733-0011	a		
19.2910.002.099		172 x 184 x 39	36.63733-0010	b		
12.1041.001.099		274 x 643 x 165	36.63732-0037			
12.1041.002.099	back	114 x 313 x 63	36.63732-0035	1		
12.1041.003.099	front	112 x 194 x 91	36.63732-0034	2		
12.1041.004.099	front	113 x 349 x 75	36.63732-0033	3		
12.1041.005.099	back	90 x 470 x 118	36.63732-0036	4		
08.5890.024.099	24V	120 x 130 x 45 mm	36.63734-0007	a		
09.1041.002.099		2400	36.25404-6033	a		
09.1041.004.099		2400	33.28104-6355	b		

2019 →
Stadtbusse MAN
(Lion's City)



MAN

1042		II (E1) 041481 IV (E1) 041482		Truck II+IV	ASA	INTEGR.
MEKRA LANG Group		Beschreibung description description description benämning popis onivcaune bűellik leirás opis		mm		OE
59.1042.001.099		685 x 176 x 237	36.63700-6017			1
59.1042.002.099		685 x 176 x 237	36.63700-6022			
59.1042.004.099		685 x 176 x 237	36.63700-6020			
59.1042.005.099		685 x 176 x 237	33.63700-6003			
59.1042.003.099		685 x 176 x 237	36.63700-6019			2
15.2780.840		178 x 307 x 22	36.63733-0011	a		
19.2910.001.099		154 x 183 x 31	36.63733-0010	b		
12.1042.001.099		232 x 528 x 87	36.63732-0040			
12.1042.002.099		232 x 528 x 87	36.63732-0041			
61.1042.005.099	for door	127 x 172 x 111				
61.1042.006.099	for A-Pillar	167 x 160 x 163				
08.5890.024.099	24V	120 x 130 x 45 mm	36.63734-0007	a		
20.1042.002.099		2100	36.63731-6012			
20.1042.003.099		2500	36.63731-6013			
09.1041.004.099		2400	33.28104-6355	b		

2019 →
Stadtbusse MAN
(Lion's City)



MERCEDES

1013 - 2644
EvoBus D 303, 404, 405, 407
08/73 - 12/86



253		II e1 02★14067 II (E1) 0114067		Truck II	ABS	Ø 18 mm
MEKRA LANG Group		Beschreibung description description description benämning popis omírcauwe üzvejlík leirats opis		mm		OE
51.2530.120H		370 x 182 x 64	381 810 25 16 + 000 810 27 16 281 810 71 16 + 000 810 62 16 000 811 12 33 + 314 810 26 16 381 810 71 16 + 663 810 08 16 673 810 08 16 + 673 810 40 16 000 811 33 33 + 001 811 87 33 000 811 20 33 + 000 811 64 33 000 811 21 33			
40.2530.222H		356 x 170 x 3	000 811 33 33 + 001 811 87 33 000 811 20 33 + 000 811 64 33 000 811 21 33			
61.2530.110H		55 x 43 x 36	000 811 02 39			
51.2530.140H		370 x 182 x 64	381 810 73 16 + 381 810 26 16 000 810 23 16 + 301 810 21 16 314 810 26 16 + 673 810 42 16			
40.2530.422H		356 x 170 x 3				
09.2070.101H		2070 x 9ø	000 150 55 33			
61.2530.110H		55 x 43 x 36	000 811 02 39			

11/77
12/98

LK08 - 1113
LN2 (LK)



254		II e1 01★14068		Truck II	ABS	Ø 18 mm
MEKRA LANG Group		Beschreibung description description description benämning popis omírcauwe üzvejlík leirats opis		mm		OE
51.2540.120H		305 x 183 x 60	314 810 13 16 + 000 810 04 16 000 810 48 16 + 673 810 39 16 000 811 35 33 + 001 811 90 33 000 811 19 33			
40.2540.222H		291 x 170 x 3	000 811 35 33 + 001 811 90 33 000 811 19 33			
61.2530.110H		55 x 43 x 36	000 811 02 39			
51.2540.130H		305 x 183 x 60	314 810 19 16 + 000 810 06 16 000 810 20 16			
40.2540.222H		291 x 170 x 3	000 811 35 33 + 001 811 90 33 000 811 19 33			
10.6211.140		282 x 162	000 821 09 29			
09.2070.101H		2070 x 9ø	000 150 55 33			
61.2530.110H		55 x 43 x 36	000 811 02 39			
51.2540.140H		305 x 183 x 60	314 810 20 16 + 673 810 41 16			
40.2540.422H		291 x 170 x 3	001 811 90 33 + 000 821 08 29			
09.2070.101H		2070 x 9ø	000 150 55 33			
61.2530.110H		55 x 43 x 36	000 811 02 39			

MERCEDES

375	II 03★0123			Ø 28 mm
	II 020941			
	II 02★0505			
	II 010505			

	Beschreibung description descripção descrizione benamining popis omircaawe birrellik leirras opis		OE

61.3752.147H		380 x 170 x 68	000 810 02 79
15.3752.470H		380 x 170 x 15	001 811 34 33+ 001 811 73 33
61.3780.100H		74 x 65 x 14	000 811 13 07

61.3752.167H		380 x 170 x 68	000 810 03 79
15.3752.470H		380 x 170 x 15	001 811 34 33+ 001 811 73 33
61.3780.100H		74 x 65 x 14	000 811 13 07

377 377-1	IV 02★0462			Ø 28 mm
	IV 010462			
	IV 03★0019			

	Beschreibung description descripção descrizione benamining popis omircaawe birrellik leirras opis		OE

61.3770.147H		200 x 200 x 155	000 810 96 16 + 001 811 21 33 + 000 811 13 07
15.3774.410H		200 x 200 x 15	001 811 21 33
61.3772.147H		200 x 200 x 118	000 810 96 16
61.3780.100H		74 x 65 x 14	000 811 13 07

61.3773.147H		200 x 200 x 155	001 810 92 16 + 000 811 13 07
15.3771.174H		200 x 200 x 15	001 811 60 33
61.3780.100H		74 x 65 x 14	000 811 13 07

375 A			Ø 28 mm

	Beschreibung description descripção descrizione benamining popis omircaawe birrellik leirras opis		OE

58.3752.100		639 x 325 x 28 ø	973 810 03 14
58.3752.200		639 x 325 x 28 ø	973 810 04 14
20.3750.710.099		136 x 82 x 73	000 811 03 61
20.3750.720.099		136 x 82 x 73	000 811 04 61

*Atego (LKN)
Axor
Unimog U 20*

*01/98 - 09/04
09/01 - 09/04*



*Atego (LKN)
Axor*

*01/98 - 09/04
09/01 - 09/04*

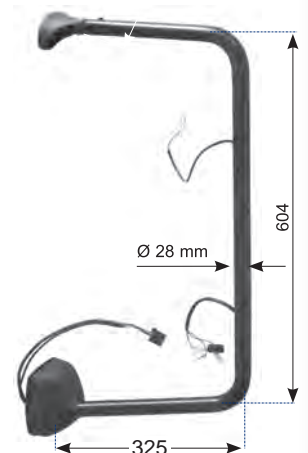

MERCEDES

MERCEDES

Atego II (LKN)
Axor II

10/04
10/04



575	II (E1) 021144	Truck II	ABS	Ø 28 mm
MEKRA LANG Group		mm		OE
Beschreibung description descripción descricao benamining popis орыцаўне őzellék opis				
51.5750.003.099		439 x 219 x 124	000 810 17 79 + 000 810 22 79	
51.5750.004.099		439 x 219 x 124	000 810 14 79 + 000 810 23 79	
09.5750.220.099		250	000 820 28 13	
51.5750.001.099		439 x 219 x 124	000 810 18 79 + 000 810 20 79	
51.5750.002.099		439 x 219 x 124	000 810 15 79 + 000 810 21 79	
09.5750.001.099		335	000 820 27 13	
19.5750.011.099		435 x 196 x 39	002 811 46 33	
15.5750.840H		431 x 186 x 15	001 811 99 33	
61.5750.100H		86 x 79 x 77	000 811 20 07	



577	IV (E1) 021145	Truck IV	ABS	Ø 28 mm
MEKRA LANG Group		mm		OE
Beschreibung description descripción descricao benamining popis орыцаўне őzellék opis				
51.5770.001.099		214 x 199 x 116	000 810 16 79 + 000 810 24 79	
19.5770.311.099		203 x 200 x 43	002 811 47 33	
15.5770.870H		192 x 186 x 15	002 811 00 33	
09.5750.220.099		250	000 820 28 13	
61.5750.100H		86 x 79 x 77	000 811 20 07	

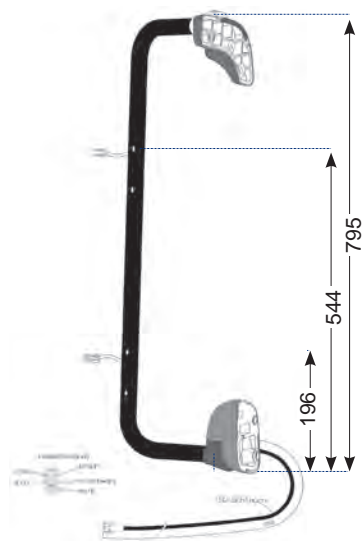

575 A		st	Ø 28 mm	
MEKRA LANG Group		mm		OE
Beschreibung description descripción descricao benamining popis орыцаўне őzellék opis				
58.5752.100H		795 x 321 x 28 ø	001 810 97 14	
58.5752.200H		795 x 376 x 28 ø	001 810 98 14	
58.5752.300H		795 x 376 x 28 ø	001 810 99 14	
58.5752.400E		795 x 321 x 28 ø	002 810 00 14	
58.5750.012.199		795 x 322 x 28 ø	002 810 85 14	
58.5750.005.199		795 x 322 x 28 ø	002 810 94 14	
20.5750.710.099		134 x 80 x 74	000 811 18 07	
20.5750.720.099		134 x 80 x 74	000 811 19 07	

MERCEDES

579	V 03★0109 V 021179			
	Beschreibung description descripção descripção benámenning popis özellik leírás opis			
56.5790.004.099		303 x 163 x 88	002 810 08 16	
15.5791.470H		303 x 163 x 55	002 811 22 33	

*Atego (LKN)
Axor
Atego II (LKN)
Axor II*

*01/98 - 05/08
09/01 - 09/04
10/04 →
10/04 →*



New Regulation ECE R46/04



MERCEDES

1004	V 04 1341			
	Beschreibung description descripção descripção benámenning popis özellik leírás opis			
56.1004.001.099		338 x 275 x 105	002 810 60 16	

396	VI 03★0017			INTEGR.
	Beschreibung description descripção descripção benámenning popis özellik leírás opis			
59.3962.210H		1261 x 303	973 810 73 16	
59.3964.210H		1145 x 265	940 810 55 16	
56.3960.148H		130 x 250 ø	000 810 08 79 + 001 811 69 33 + 000 811 13 07	
15.3961.174H		45 x 250 ø	001 811 69 33	
61.3780.100H		74 x 65 x 14	000 811 13 07	



MERCEDES

Actros (SKL) I+II
Econic

09/96
03/98



378 378-1	II [E1] 02★0463 II [E1] 010463 II [E1] 03★0018		Ø 28 mm
----------------------------	--	--	---------

	Beschreibung description descripção descripziune benamning poppis õniveaune bireilik õpits		mm	OE
--	--	--	----	----

61.3780.147H		433 x 188 x 85	
15.3784.470H		433 x 188 x 15	001 811 20 33
61.3782.147H		433 x 188 x 68	000 810 95 16
61.3780.100H		74 x 65 x 14	000 811 13 07
61.3783.147H		433 x 188 x 68	
15.3780.840H		433 x 188 x 15	002 811 04 33
61.3780.100H		74 x 65 x 14	000 811 13 07
61.3782.167H		433 x 188 x 68	000 810 94 16
15.3784.470H		433 x 188 x 15	001 811 20 33
61.3780.100H		74 x 65 x 14	000 811 13 07
61.3783.167H		433 x 188 x 68	
15.3780.840H		433 x 188 x 15	002 811 04 33
61.3780.100H		74 x 65 x 14	000 811 13 07

Actros (SKL) I+II
Econic

09/96 - 05/08
03/98



377 377-1	IV [E1] 02★0462 IV [E1] 010462 IV [E1] 03★0019		Ø 28 mm
----------------------------	--	--	---------

	Beschreibung description descripção descripziune benamning poppis õniveaune bireilik õpits		mm	OE
--	--	--	----	----

61.3770.147H		200 x 200 x 155	
15.3774.410H		200 x 200 x 15	001 811 21 33
61.3772.147H		200 x 200 x 118	000 810 96 16
61.3780.100H		74 x 65 x 14	000 811 13 07
61.3773.147H		200 x 200 x 155	
15.3771.174H		200 x 200 x 15	001 811 60 33
61.3780.100H		74 x 65 x 14	000 811 13 07

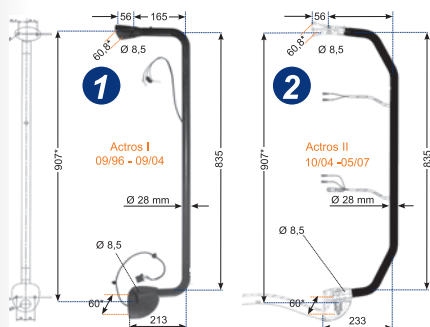

378 A			Ø 28 mm
--------------	--	--	---------

	Beschreibung description descripção descripziune benamning poppis õniveaune bireilik õpits		mm	OE
--	--	--	----	----

58.3781.100H		983 x 197 x 28 ø	001 810 44 14
58.3781.200H		983 x 197 x 28 ø	001 810 45 14
58.3783.300H		983 x 227 x 28 ø	002 810 08 14
58.3783.200H		983 x 227 x 28 ø	002 810 09 14
20.3780.700H		96 x 91 x 88	941 811 00 07

MERCEDES

579	V e1 03★0109			
	V (E1) 021179			
	Beschreibung description descripção descrizione benamining popis описанье őzellik leírás opis			OE
56.5790.004.099		303 x 163 x 88	002 810 08 16	
15.5791.470H		303 x 163 x 55	002 811 22 33	

*Actros (SKL) I+II
Econic*
09/96 - 05/08
03/98 →



1004	V (E1) 04 1341			
	Beschreibung description descripção descrizione benamining popis описанье őzellik leírás opis			OE
56.1004.001.099		338 x 275 x 105	002 810 60 16	

New Regulation ECE R46/04



396	V e1 03★0017			INTEGR.
	Beschreibung description descripção descrizione benamining popis описанье őzellik leírás opis			OE
59.3965.210H		1219 x 303	943 810 47 16	
56.3960.148H		130 x 250 ∅	000 810 08 79 + 001 811 69 33 + 000 811 13 07	
15.3961.174H		45 x 250 ∅	001 811 69 33	
61.3780.100H		74 x 65 x 14	000 811 13 07	

Actros I + II



MERCEDES

MERCEDES

ACTROS MP3



1012	ECE	II + IV Truck		
MEKRA LANG Group	Beschreibung description descripção descripziune benamning popis opisacune özelliik leirás opis		OE	
19.1012.002.099		1200 24V	a	401 x 200 x 55 002 811 33 33
19.1012.003.099		1200 24V	a	401 x 200 x 55 002 811 34 33
19.1012.000.099		300 24V	b	196 x 193 x 44 002 811 37 33
19.1012.001.099		300 24V	b	196 x 193 x 44 002 811 38 33

MERCEDES

ACTROS MP4
ANTOS
AROCS
(SFTP)



10/2011
07/2012
05/2013

600	II (E1) 02★1112 IV (E1) 02★1113	II + IV Truck	ABS	INTEGR.
MEKRA LANG Group	Beschreibung description descripção descripziune benamning popis opisacune özelliik leirás opis		OE	
15.6000.001.099		1200 24V	a	430 x 193 x 34 002 811 63 33
15.6000.002.099		1200 24V	a	430 x 193 x 34 002 811 64 33
15.6000.003.099		300 24V	b	204 x 236 x 51 002 811 65 33
15.6000.004.099		300 24V	b	204 x 236 x 51 002 811 66 33

Komplettsystem (MP3 + MP4) bei Mercedes erhältlich
complete system (MP3 + MP4) available at Mercedes

ACTROS MP3
ACTROS MP4
ANTOS
AROCS
(SFTP)



10/2011
07/2012
05/2013

1004	V (E1) 04 1341	V Truck	ABS	
MEKRA LANG Group	Beschreibung description descripção descripziune benamning popis opisacune özelliik leirás opis		OE	
56.1004.001.099				338 x 275 x 105 002 810 60 16

New Regulation ECE R46/04

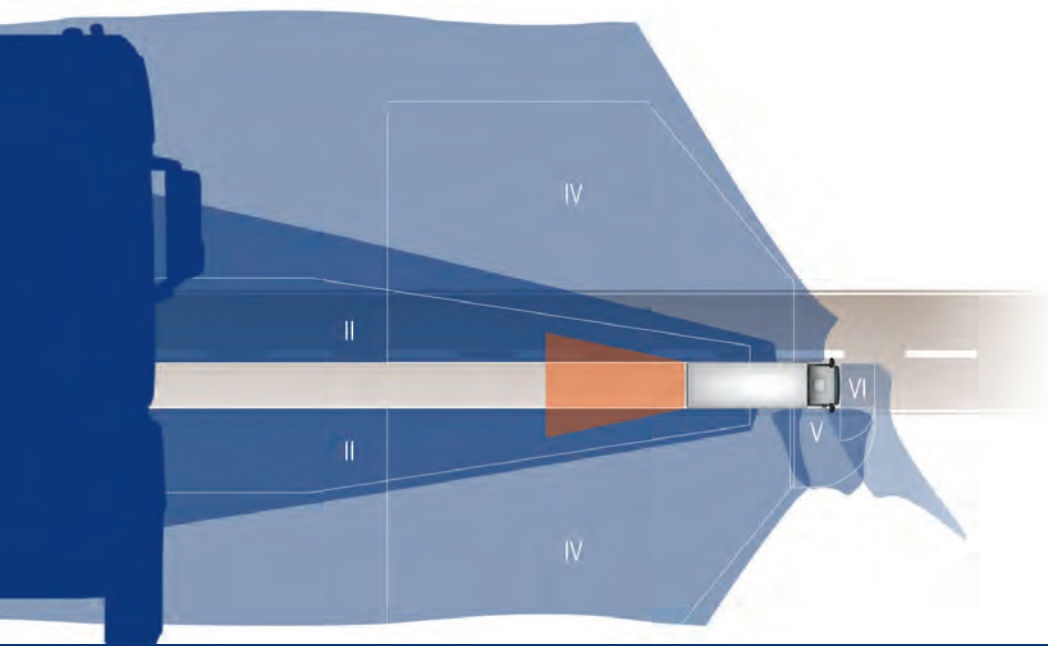

Mirror replacement system

MEKRA Lang - Electronics supplier for indirect vision

NEW

Electronics catalogue release in 2022



Camera Monitor System



Turn Assist System

MERCEDES

1994 →
EvoBus Kombibus
Ares (Renault, Karosa, Iveco)



281	II E1 02★0447	Truck II	ABS	INTEGR.
	II E1 010447			
	II E1 02★0448			
MEKRA LANG Group		mm		OE
59.2810.111H		470 x 230 x 85		
59.2810.113H		470 x 230 x 85		
15.2810.480H		409 x 168 x 6		
11.2810.200H		460 x 180 x 50		

1999 →

Conecto CÜ
Intouro



398	II E1 03★0123	Truck II	ABS	OE	
	II E1 020941				
	II E1 02★0505				
	II E1 010505				
MEKRA LANG Group		mm		OE	
1	59.3980.021H		90°	551 x 278 x 147	671 810 09 16
	59.3980.022H		90°	551 x 1278 x 47	671 810 13 16
2	59.3980.121		21°	435 x 246 x 143	628 810 30 16
	59.3980.122		21°	435 x 246 x 143	628 810 31 16
3	59.3980.011H		110°	474 x 733 x 166	671 810 07 16
	59.3980.012		110°	474 x 733 x 166	671 810 12 16
	59.3980.111		132°	474 x 733 x 166	628 810 33 16
	59.3980.112		132°	474 x 733 x 166	628 810 34 16
4	59.3980.132		132°	622 x 758 x 224	628 810 37 16
	59.3980.141		110°	622 x 758 x 224	633 810 01 16
	59.3980.142		110°	622 x 758 x 224	633 810 02 16
	61.3752.147H			380 x 170 x 68	000 810 02 79
	61.3752.167H			380 x 170 x 68	000 810 03 79
	15.3752.470H			380 x 170 x 15	001 811 34 33 + 001 811 73 33
	61.3773.147H			200 x 200 x 155	001 810 92 16
	15.3771.174H			200 x 200 x 15	001 811 60 33
	61.3780.100H			74 x 65 x 14	000 811 13 07
	20.2480.216H			108 x 50 x 15 [2000]	
	20.2480.217H			108 x 50 x 15 [5000]	



09/97 →
10/03 →
09/99 →
09/97 →
Travego
Tourino
Setra TC 400
Multego
Tourismo



395	II E1 02★0620	II E1 020926	II + V	OE	
	II E1 010620	V E1 03★0174			
	II E1 03★0047	V E1 020998			
MEKRA LANG Group		mm		OE	
	15.3951.174		a	368 x 174 x 15	629 811 00 33
	15.3952.174		a	368 x 174 x 15	629 811 02 33
	15.3951.114		b	202 x 153 x 15	629 811 01 33

MERCEDES

249 K	III e1 01★17023			① Ø 10 mm ② Ø 12 mm
Beschreibung description descripção descripziune descripziôn benamining popis opnycawne bërellik leirás opis				OE
51.2491.121H		①	210 x 140 x 21	460 810 01 16 + 601 810 02 16 460 810 03 16
51.2491.122H		②	210 x 140 x 21	601 810 01 16

249 L	II e1 02★14035 II (E1) 0114035			① Ø 10 mm ② Ø 14 - 20 mm
Beschreibung description descripção descripziune descripziôn benamining popis opnycawne bërellik leirás opis				OE
51.2493.121H		①	247 x 157 x 61	612 810 01 66 + 611 810 01 16
51.2493.127H		②	247 x 157 x 61	

349 349 TW	II e1 02★0384 II (E) 010384 II e1 02★0418 II (E) 010418			① INTEGR. ③ Ø 18 mm
Beschreibung description descripção descripziune descripziôn benamining popis opnycawne bërellik leirás opis				OE
51.3490.110H		①	283 x 295 x 80	901 810 01 16 + 901 810 55 16
15.3491.071H			238 x 142 x 6	001 811 06 33
51.3490.120H			283 x 340 x 80	901 810 02 16 + 901 810 64 16
15.3491.072H			238 x 142 x 6	001 811 07 33
51.3490.112H			283 x 295 x 80	901 810 09 16 + 901 810 57 16
15.3491.371H			238 x 142 x 6	001 811 05 33
51.3490.122H			283 x 340 x 80	901 810 10 16 + 901 810 66 16
15.3491.372H			238 x 142 x 6	001 811 04 33
56.3491.110H		②	175 x 116 x 70	901 810 10 93 + B 66 5603 97
15.2711.214H			165 x 93 x 15	
56.3492.110H			175 x 116 x 70	901 810 11 93 + B 66 5603 98
15.2711.214H			165 x 93 x 15	
59.3491.110H		③	283 x 495 x 80	901 810 25 16 + 901 810 58 16
59.3492.110H			283 x 465 x 80	901 810 37 16 + 901 810 61 16
15.3491.071H			238 x 142 x 6	001 811 06 33
59.3491.120H			283 x 535 x 80	901 810 26 16 + 901 810 67 16
59.3492.120H			283 x 535 x 80	901 810 38 16 + 901 810 70 16
15.3491.072H			238 x 142 x 6	001 811 07 33

05/77 - 07/81
05/79 →
Transporter
207D - 308 (T1, TN)
Typ 230 GE, 280 GE
Typ 240 GD, 300 GD



08/81 - 02/95
Transporter
207D - 410 (T1, TN)



01/95 - 09/05
Sprinter (T1N)

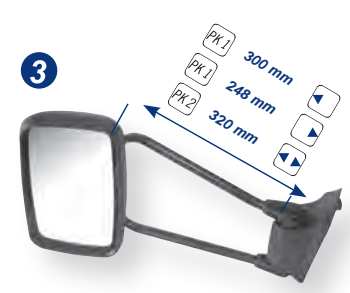

MERCEDES

MERCEDES

589

II III e1 03★0006

II III E1 020902



ABS

INTEGR.



Beschreibung
description
description
descricao
descrioione
benamining
ppos
ömr/cawne
ürelük
reiräs
öpis



OE

*Mercedes Sprinter II (NCV3)
10/2005 - 11/2017*

MERCEDES



* mit beheizter Weitwinkel - Glaseinheit, nur verwendbar für Fahrzeuge ab "EURO 5" with heated wide angle mirror glass unit, suitable from "EURO 5" vehicles only

L H D	1	51.5891.111.199										344 x 315 x 182	906 810 48 16 + 906 810 18 93	
		51.5891.112.199 *										344 x 315 x 182	906 810 30 93	
		51.5891.113.199										344 x 315 x 182	906 810 60 16	
		51.5891.114.199 *										344 x 315 x 182	906 810 42 93	
		51.5894.112.199 *										344 x 315 x 182	906 810 65 93	
	R H D		51.5891.311.199										344 x 345 x 182	906 810 51 16 + 906 810 21 93
			51.5894.310.199										344 x 345 x 182	906 810 64 93
			51.5891.312.199 *										344 x 345 x 182	906 810 33 93
			51.5891.313.199										344 x 345 x 182	906 810 63 16
		51.5891.314.199 *										344 x 345 x 182	906 810 45 93	
L H D		51.5891.211.199										344 x 345 x 182	906 810 49 16 + 906 810 19 93	
		51.5891.212.199 *										344 x 345 x 182	906 810 31 93	
		51.5891.213.199										344 x 345 x 182	906 810 61 16	
		51.5891.214.199 *										344 x 345 x 182	906 810 43 93	
		51.5894.212.199 *										344 x 345 x 182	906 810 66 93	
R H D		51.5891.411.199										344 x 315 x 182	906 810 50 16 + 906 810 20 93	
		51.5894.410.199										344 x 315 x 182	906 810 63 93	
		51.5891.412.199 *										344 x 315 x 182	906 810 32 93	
		51.5891.413.199										344 x 315 x 182	906 810 62 16	
		51.5891.414.199 *										344 x 315 x 182	906 810 44 93	
L H D	2	51.5892.111.199										344 x 509 x 182	906 810 52 16 + 906 810 22 93	
		51.5892.112.199 *										344 x 509 x 182	906 810 34 93	
		51.5892.113.199										344 x 509 x 182	906 810 64 16	
	R H D		51.5892.311.199										344 x 460 x 182	906 810 55 16 + 906 810 25 93
			51.5892.312.199 *										344 x 460 x 182	906 810 37 93
			51.5892.313.199										344 x 460 x 182	906 810 67 16
	51.5895.312.199 *										344 x 460 x 182	906 810 80 93		
L H D		51.5892.211.199										344 x 460 x 182	906 810 53 16 + 906 810 23 93	
		51.5892.212.199 *										344 x 460 x 182	906 810 35 93	
		51.5892.213.199										344 x 460 x 182	906 810 65 16	
R H D		51.5892.411.199										344 x 509 x 182	906 810 54 16 + 906 810 24 93	
		51.5892.413.199										344 x 509 x 182	906 810 66 16	
		51.5895.412.199 *										344 x 509 x 182	906 810 79 93	
L H D	3	51.5893.111.199										344 x 543 x 182	906 810 56 16 + 906 810 26 93	
		51.5893.112.199 *										344 x 543 x 182	906 810 38 93	
		51.5893.113.199										344 x 543 x 182	906 810 68 16	
		51.5893.211.199										344 x 511 x 182	906 810 57 16 + 906 810 27 93	
		51.5893.212.199 *										344 x 511 x 182	906 810 39 93	
		51.5893.213.199										344 x 511 x 182	906 810 69 16	

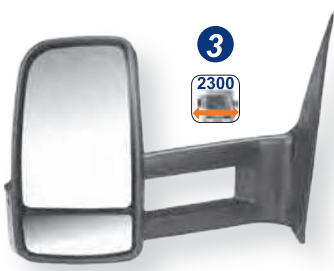

MERCEDES

589

II III e1 03★0006

II III E1 020902



Beschreibung
description
descripção
descrizione
description
Pops
Pops
Pops
Pops
Pops
Pops
Pops
Pops



OE

15.5891.741H		236 x 155 x 16	002 811 15 33	a
15.5891.742H		236 x 155 x 16	002 811 16 33	
15.5891.611H		154 x 59 x 19	002 811 19 33	b
15.5891.612H		154 x 59 x 19	002 811 20 33	
19.5890.011.099		240 x 158 x 21	002 811 52 33	c
19.5890.012.099		240 x 158 x 21	002 811 53 33	
19.5891.011.099		240 x 158 x 21	002 811 56 33	
19.5891.012.099		240 x 158 x 21	002 811 57 33	
08.5890.300.099		113 x 32 x 15	000 440 00 15	
08.5890.301.099		113 x 32 x 15	000 440 01 15	
15.5891.721.099		157 x 65 x 20	002 811 39 33	d
15.5891.722.099		157 x 65 x 20	002 811 40 33	
13.5890.110.199		344 x 218 x 82	000 811 10 22	
13.5890.210.199		344 x 218 x 82	000 811 11 22	
13.5890.120.099		344 x 201 x 82	001 811 00 22	
13.5890.220.099		344 x 201 x 82	001 811 01 22	
14.5890.100.099		337 x 192 x 56	000 813 04 36	
14.5890.200.099		337 x 192 x 56	000 813 05 36	
08.5892.001.099		13 133 x 118 x 88	001 822 89 20 + 000 820 12 77	
08.5892.002.099		13 133 x 118 x 88	001 822 93 20 + 000 820 12 77	
08.5892.003.099		13 133 x 118 x 88	001 822 90 20 + 000 820 12 77	
08.5892.004.099		13 133 x 118 x 88	001 822 92 20 + 000 820 12 77	
08.5892.105.099		12 51 x 27 ø	000 820 12 77	

Mercedes Sprinter II
(NCV3) 10/05 - 09/10



MERCEDES

Sprinter II
Euro 5 + 6 10/2010 - 11/2017



ab Fahrgestellnr. starting with chassis no.
906 155 1 N 463 439



ab Fahrgestellnr. starting with chassis no.
906 155 1 N 416 545



2018

MERCEDES

1039

NEW

II (E1) 041469



ABS

INTEGR.



Beschreibung
description
description
descrição
description
benamning
pops
omrcauwe
bœreilic
reirais
opis



OE

Sprinter III
W907 und W910

MERCEDES



LHD

RHD



59.1039.125.099		423 x 280 x 160	9108100300
59.1039.225.099		423 x 280 x 160	9108100400
59.1039.101.099		423 x 280 x 160	9108108901
59.1039.201.099		423 x 280 x 160	9108109001
59.1039.104.099		423 x 280 x 160	9108101100
59.1039.204.099		423 x 280 x 160	9108101200
59.1039.105.099		423 x 280 x 160	9108101900
59.1039.205.099		423 x 280 x 160	9108102000
59.1039.175.099		423 x 280 x 160	9108100500
59.1039.275.099		423 x 280 x 160	9108100600
59.1039.151.099		423 x 280 x 160	9108109101
59.1039.251.099		423 x 280 x 160	9108109201
59.1039.158.099		423 x 280 x 160	9108109501
59.1039.258.099		423 x 280 x 160	9108109601
59.1039.154.099		423 x 280 x 160	9108101300
59.1039.254.099		423 x 280 x 160	9108101400
59.1039.155.099		423 x 280 x 160	9108102100
59.1039.255.099		423 x 280 x 160	9108102200
19.1039.411.099		207 x 139 x 20	9108112500
19.1039.412.099		207 x 139 x 20	9108112400
19.1039.011.099		207 x 139 x 20	9108112700
19.1039.012.099		207 x 139 x 20	9108112600
19.1039.811.099		207 x 139 x 20	9108112900
19.1039.812.099		207 x 139 x 20	9108112800
19.1039.311.099		137 x 70 x 20	9108113700
19.1039.312.099		137 x 70 x 20	9108113600
13.1039.001.099		308 x 216 x 104	9108114100
13.1039.002.099		308 x 216 x 104	9108114000
11.1039.011.099		308 x 189 x 60	9108113900
11.1039.012.099		308 x 189 x 60	9108113800
08.1039.011.099		Ø 38 x 15	9109065600
61.1039.002.099		Ø 36 x 19	9108250400
08.1039.001.099		87 x 67 x 54	9109064700
08.1039.002.099		87 x 67 x 54	9109064600
11.1039.001.099		62 x 87 x 27	9108114500
11.1039.002.099		62 x 87 x 27	9108114400
08.1039.005.099		35 x 42 x 12	9105420100
08.1039.006.099		35 x 42 x 12	9105420000

MERCEDES

1039 **NEW** II III (E1) 02★0902  ABS INTEGR.

 Beschreibung description descrição descriçãoe descriçioe benamining p-pops omurcauwe öürelük letraks optis  mm OE

59.1039.525.099		423 x 447 x 270	9108100401	2	L H D
59.1039.625.099		423 x 447 x 270	9108100501		
59.1039.501.099		423 x 447 x 270	9108100801		
59.1039.601.099		423 x 447 x 270	9108100901		
59.1039.575.099		423 x 447 x 270	9108100601		
59.1039.675.099		423 x 447 x 270	9108100701		
59.1039.551.099		423 x 447 x 270	9108101001		
59.1039.651.099		423 x 447 x 270	9108101101		
59.1039.558.099		423 x 447 x 270	9108107001		
59.1039.658.099		423 x 447 x 270	9108107101		
59.1039.701.099		423 x 502 x 343	9108101601	3	L H D
59.1039.801.099		423 x 502 x 343	9108101701		
59.1039.751.099		423 x 502 x 343	9108101801		
59.1039.851.099		423 x 502 x 343	9108101901		
19.5890.011.099		8 240 x 158 x 21	0028115233	2 + 3	
19.5890.012.099		8 240 x 158 x 21	0028115333		
15.5891.721.099		9 157 x 65 x 20	0028113933		
15.5891.722.099		9 157 x 65 x 20	0028114033		
13.5890.110.199		10 344 x 218 x 82	0008111022		
13.5890.120.099		10 344 x 218 x 82	0018110022		
13.5890.210.199		10 344 x 218 x 82	0008111122		
13.5890.220.099		10 344 x 218 x 82	0018110122		
14.5890.100.099		11 337 x 192 x 56	0008130436		
14.5890.200.099		11 337 x 192 x 56	0008130536		
08.5892.105.099		12 Ø 51 x 27	0008201277		
08.5892.002.099		13 133 x 118 x 88	0018229320 + 0008201277		
08.5892.003.099		13 133 x 118 x 88	0018229420 + 0008201277		

Sprinter III
W907 und W910



RENAULT

390	II E1 03★0009 II E 020914 IV E1 03★0037 IV E 020916			INTEGR.
------------	--	--	--	----------------

	Beschreibung description descripción descrizione benámenning popis ömörcauwe özellik opis		mm	OE
--	---	--	----	----

59.3900.143H		880 x 340 x 155	50.10.623.231
59.3901.143H		880 x 340 x 155	50.10.623.689
59.3900.243H		880 x 340 x 155	50.10.623.232 + 74.21.326.527
59.3900.133H		880 x 440 x 155	50.10.623.246
59.3901.133H		880 x 440 x 155	50.10.623.697
59.3900.233H		880 x 440 x 155	50.10.623.247 + 74.21.326.526
59.3901.233H		880 x 440 x 155	50.10.623.698 + 74.21.326.554
59.3900.343H		880 x 340 x 155	
59.3900.443H		880 x 340 x 155	
59.3900.333H		880 x 440 x 155	
59.3900.433H		880 x 440 x 155	
15.3900.840H		337 x 202 x 25	74.20.862.795
15.3911.871H		200 x 197 x 75	74.20.862.810
15.3911.872H		200 x 197 x 75	74.20.862.815
61.3900.100H		373 x 245 x 101	74.20.862.782
61.3900.110H		373 x 245 x 101	74.20.866.665
61.3900.120H		373 x 245 x 101	74.20.913.815 + 74.85.120.820
61.3900.130H		373 x 245 x 101	74.85.120.820
61.3911.110H		245 x 236 x 105	74.20.862.809
61.3911.120H		245 x 236 x 105	74.20.862.813
11.3900.200H		371 x 244 x 80	74.20.862.779
11.3900.201H		371 x 247 x 80	74.20.903.714
11.3910.200H		244 x 225 x 75	74.20.862.800
11.3910.201H		244 x 225 x 75	74.20.903.736
08.5752.024.099		130 x 120 x 53	74.20.866.672 + 74.20.862.812 74.21.618.499
09.3900.003.000		300 x 6 ø	74.21.614.025
20.3900.510H		518 x 160 x 98	50.10.623.057
20.3900.520H		518 x 160 x 98	50.10.623.058

Midlum 1818
 Premium Distribution
 Kerax
 D-Serie
 C-Serie (2,3 m)

05/06 - 09/13
 05/06 - 09/13
 05/06 - 09/13
 10/13
 10/13

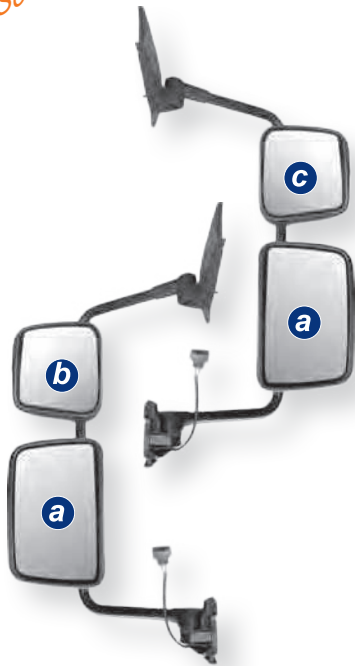

RENAULT

RENAULT

390		II [e1] 03★0009 II [e] 020914 IV [e1] 03★0010 IV [e] 020913	II + IV Truck	ABS	INTEGR.
MEKRA LANG Group		Beschreibung description descripção descripziune benamning Popis özellik leirats opts	mm		OE
59.3900.123H		880 x 340 x 155	50.10.578.503		
59.3901.123H		880 x 340 x 155	50.10.578.505		
59.3900.223H		880 x 340 x 155	50.10.578.504 + 74.21.326.550		
59.3901.223H		880 x 340 x 155	50.10.578.506 + 74.21.326.551		
59.3900.323H		880 x 340 x 155			
59.3900.423H		880 x 340 x 155			
15.3900.840H		337 x 202 x 25	74.20.862.795	a	
15.3910.871H		203 x 189 x 75	74.20.903.745	b	
15.3910.872H		203 x 189 x 75	74.20.903.746	c	
61.3900.100H		373 x 245 x 101	74.20.862.782		
61.3900.110H		373 x 245 x 101	74.20.866.665		
61.3900.120H		373 x 245 x 101	74.20.913.815 + 74.85.120.820		
61.3900.130H		373 x 245 x 101	74.85.120.820		
61.3910.110H		300 x 230 x 105	74.20.904.268		
61.3910.120H		300 x 230 x 105	74.20.904.269		
11.3900.100H		371 x 244 x 80	74.20.903.880		
11.3900.101H		371 x 244 x 80	74.20.903.881		
11.3910.110H		303 x 244 x 75	74.20.903.882		
11.3910.111H		303 x 244 x 75	74.20.903.885		
11.3910.120H		303 x 244 x 75	74.20.903.883		
11.3910.121H		303 x 244 x 75	74.20.903.887		
08.5752.024.099		130 x 120 x 53	74.20.866.672 + 74.20.862.812 74.21.618.499		
09.3900.003.000		300 x 6 ø	74.21.614.025		
20.3900.510H		518 x 160 x 98	50.10.623.057		
20.3900.520H		518 x 160 x 98	50.10.623.058		

Premium Route 2711 10/05 - 09/13

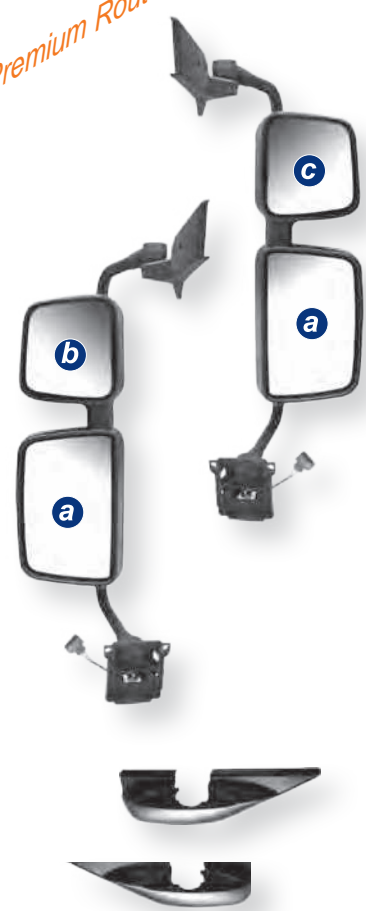

RENAULT

Premium Route 2711 10/05 - 09/13
 Midlum 1818 05/06 - 09/13
 Premium Distribution 05/06 - 09/13
 Kerax 10/13
 D-Serie 10/13
 C-Serie (2,3 m) 10/13

552-1		V VI [e1] 03★0033 V VI [E1] 020894	VI Truck	ABS	INTEGR.
MEKRA LANG Group		Beschreibung description descripção descripziune benamning Popis özellik leirats opts	mm		OE
59.5524.648.099		725 x 319 x 126	74.20.849.837 + 74.82.226.025	1	
51.5524.930H		316 x 186 x 77	74.21.020.285		
59.5524.649.099		437 x 319 x 103	74.20.849.835 + 74.82.226.027	2	
51.5524.930H		316 x 186 x 77	74.21.020.285		



Premium, Gamme R/G
Midlum / Kerax → 09/2005



348		II 03★0184 II 021022			Ø 22 mm
MEKRA LANG Group		Beschreibung description descrição descrizione description benamning popis omicaune üzeylik leirás opis	mm		OE
61.3481.149H	1	395 x 205 x 145	50.01.856.290		
15.3480.840H		372 x 189 x 32			
11.3480.100		169 x 88 x 27			
61.3480.149H	2	382 x 193 x 85	50.01.853.675 + 50.01.856.292 50.01.833.026		
40.3485.412H		375 x 190 x 3			

RENAULT



348		IV 03★0185 IV 021023			Ø 22 mm
MEKRA LANG Group		Beschreibung description descrição descrizione description benamning popis omicaune üzeylik leirás opis	mm		OE
61.3482.149H		199 x 199 x 97	74.21.276.373		
40.3485.403H		191 x 191 x 3			



558		V 03★0011 V 020912			
MEKRA LANG Group		Beschreibung description descrição descrizione description benamning popis omicaune üzeylik leirás opis	mm		OE
59.5580.247H		260 x 229 x 70	50.10.578.511		
59.5580.147H		260 x 229 x 70			

10/13
10/13

D-Serie
C-Serie (2,3 m)



1025		V 04★1345			
MEKRA LANG Group		Beschreibung description descrição descrizione description benamning popis omicaune üzeylik leirás opis	mm		OE
59.1025.001.099		315 x 179 x 220	7484531138		
59.1025.002.099		315 x 179 x 220	7484531168		

New Regulation ECE R46/04

SCANIA

400				INTEGR.
	Beschreibung description descripção descrizione description benámenning poppis описание Dzællik leirás opis		OE	
15.4001.840H		432 x 200 x 20	176 5985	
15.4001.740H		184 x 160 x 20	176 7265	

Komplettspiegel erhältlich bei SCANIA
complete mirror available at SCANIA

558	V 03★0011 V 020912			
	Beschreibung description descripção descrizione description benámenning poppis описание Dzællik leirás opis		OE	
59.5581.100H		260 x 229 x 77	152 7773	

1005	V 04★1336 V 041336			
	Beschreibung description descripção descrizione description benámenning poppis описание Dzællik leirás opis		OE	
59.1005.003.099		326 x 202 x 214	2382791	

New Regulation ECE R46/04

1019	NEW	II 041391 IV 041392		
	Beschreibung description descripção descrizione description benámenning poppis описание Dzællik leirás opis		OE	
19.1019.013.099		400 x 208 x 29	2116845	
19.1019.014.099		400 x 208 x 29	2116846	
19.1019.313.099		219 x 196 x 39	2116848	
19.1019.314.099		219 x 196 x 39	2116849	

Serie 4 (NGS)
Serie R/P/T/G
95 - 07/04
08/04 →



124 / 144 (Serie 400) 1996 - 07/04



08/04 →

Serie 4 R/P/T/G



2016 →

Serie L/P/G



SCANIA

F7, F10, F12
12/77 - 08/85



VOLVO		II e1 01★14002		Truck II	ABS	Ø 14-20 mm
MEKRA LANG Group		Beschreibung description descripção descripziune descripción benamining popis omicaune üzellik leirras opsis		mm		OE
51.2500.127H		375 x 183 x 26	1581 550			
40.2500.222H		366 x 176 x 3	1581 599			
51.2500.147H		375 x 183 x 26	1594 412 ♦ 1581 616 1594 411			
40.2500.422H		366 x 176 x 3	1581 602 ♦ 1594 415			
09.2070.101H		2070 x 9ø	2108 3541			

FL4, FL6, FL7, FL10
F10, F12, F16
NL10, NL12
09/85 - 9/94
09/85 - 9/93
1972 - 8/85



VOLVO		II E1 02★14089 II E1 0114089		Truck II	ABS	Ø 14-20 mm
MEKRA LANG Group		Beschreibung description descripção descripziune descripción benamining popis omicaune üzellik leirras opsis		mm		OE
51.2520.127H		444 x 208 x 84	1599 462 ♦ 3090 395			
40.2520.222H		429 x 194 x 3	1697 007 ♦ 2085 4576			
51.2520.147H		444 x 208 x 84	1594 902 ♦ 1621 353 1195 934 ♦ 3090 396			
40.2520.422H		429 x 194 x 3	1697 008 ♦ 3093 519			
09.2070.101H		2070 x 9ø	2108 3541			

FH
FM
NH
10/93 - 03/02
08/98 - 03/02
05/99



VOLVO		II e1 02★14125 II E1 0114125		Truck II	ABS	INTEGR.
MEKRA LANG Group		Beschreibung description descripção descripziune descripción benamining popis omicaune üzellik leirras opsis		mm		OE
15.3702.470H		433 x 198 x 16	3090 737 ♦ 3091 756 3092 854 ♦ 2085 4564			

FH I + FH II
FM I + FM II
1
2
100 mm
50 mm



VOLVO		V E1 02★12013 V E1 0112013 V E1 03★0039 V E1 020973		Truck V	ABS	
MEKRA LANG Group		Beschreibung description descripção descripziune descripción benamining popis omicaune üzellik leirras opsis		mm		OE
59.3601.128H		284 x 174 x 62	1096 643			
40.3605.204F		272 x 162 x 3	3090 734 ♦ 2085 4583			
59.3601.178H		284 x 174 x 64	2120 3313			
40.3605.203H		272 x 162 x 3				
59.3601.188H		284 x 174 x 64				
40.3605.403H		272 x 162 x 3				
59.3602.128H		284 x 174 x 62	3126 117			
40.3605.204F		272 x 162 x 3	3090 734 ♦ 2085 4583			

VOLVO

390	II [e1] 03★0009			INTEGR.
	II (E) 020914			
	IV [e1] 03★0037			
	IV (E) 020916			

MEKRA LANG Group	Beschreibung description description descripção description benamning popis özellik leirás opis				mm	OE
59.3900.143H					880 x 340 x 155	2020 7881 + 2070 7881 2090 3722
59.3900.243H					880 x 340 x 155	2074 3983 + 2132 6527
59.3900.133H					880 x 440 x 155	2070 7874
59.3900.233H					880 x 440 x 155	2070 8303 + 2147 5603 2132 6526
59.3900.343H					880 x 340 x 155	
59.3900.443H					880 x 340 x 155	
59.3900.333H					880 x 440 x 155	
59.3900.433H					880 x 440 x 155	
15.3900.840H					337 x 202 x 25	2086 2795
15.3911.871H					200 x 197 x 75	2086 2810
15.3911.872H					200 x 197 x 75	2086 2815
61.3900.100H					373 x 245 x 101	2086 2782
61.3900.110H					373 x 245 x 101	2086 6665
61.3900.120H					373 x 245 x 101	
61.3900.130H					373 x 245 x 101	8512 0820
61.3911.110H					245 x 236 x 105	2086 2809
61.3911.120H					245 x 236 x 105	2086 2813
11.3900.200H					371 x 244 x 80	2086 2779
11.3910.200H					244 x 225 x 75	2086 2800
08.5752.024.099					130 x 120 x 53	2086 6672 + 2086 2812 2161 8499
09.3900.003.000					300 x 6 ø	2161 4025
20.3900.510H					518 x 160 x 98	2070 8110
20.3900.520H					518 x 160 x 98	2070 8230

552-1	V VI [e1] 03★0033			INTEGR.
	V VI (E) 020894			

MEKRA LANG Group	Beschreibung description description descripção description benamning popis özellik leirás opis				mm	OE
59.5524.648.099					725 x 319 x 126	2084 9837
51.5524.930H					316 x 186 x 77	2102 0285

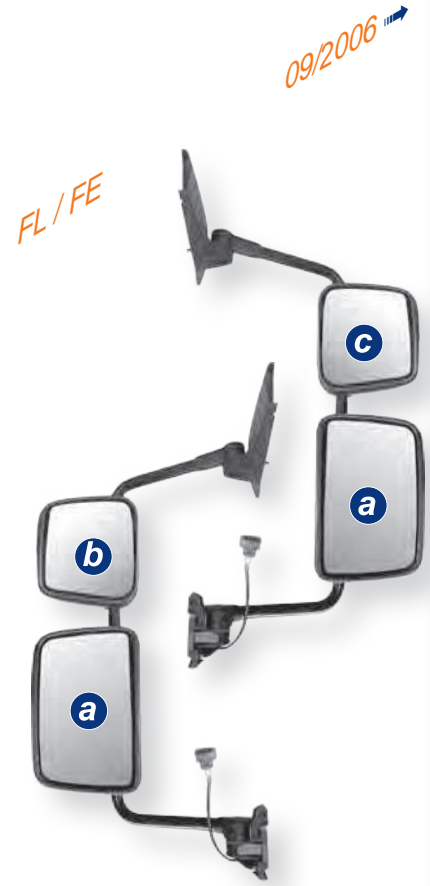

VOLVO

FL / FE



09/06

New Regulation ECE R46/04

VOLVO			
1025	V e1 04★1345	Truck	ABS
MEKRA LANG Group		mm	
Beschreibung description descrição descrição descrição benámining popis omivcawie üzelliik leiřas opis		OE	
59.1025.001.099		315 x 179 x 220	8453 1138
59.1025.002.099		315 x 179 x 220	8453 1168

FH 2 / FM 2



04/02 - 09/2012

224		Truck	ABS	INTEGR.
MEKRA LANG Group		mm		OE
Beschreibung description descrição descrição descrição benámining popis omivcawie üzelliik leiřas opis		mm		OE
15.2240.840H		431 x 197 x 30	2056 7670 + 2132 0383	

Komplettspiegel erhältlich bei VOLVO
complete mirror available at VOLVO

10/10 - 12/2015

FMX



572	II e1 03★0031 II (E1) 020918	Truck	ASA	Ø 22 / 28 mm
MEKRA LANG Group		mm		OE
Beschreibung description descrição descrição descrição benámining popis omivcawie üzelliik leiřas opis		mm		OE
61.5721.006.099		426 x 200 x 135	8247 1690	
61.5721.005.099		426 x 200 x 135	8247 1688	
40.5725.412H		412 x 188 x 3	8241 7041	
61.5721.004.099		78 x 69 x 38	8247 2612	
11.5721.001.099		427 x 199 x 36	8241 7042	
08.5380.004.000		72 x 75 x 36		



573	IV e1 03★0032 IV (E1) 020917	Truck	ASA	Ø 22 / 28 mm
MEKRA LANG Group		mm		OE
Beschreibung description descrição descrição descrição benámining popis omivcawie üzelliik leiřas opis		mm		OE
61.5731.001.099		202 x 198 x 126	8247 1689	
40.5735.403H		190 x 184 x 3	8241 7044	
61.5721.004.099		78 x 69 x 38	8247 2612	
11.5731.001.099		202 x 198 x 27	8241 7045	

VOLVO

1000 1043/1044	II 041541	II 021108			INTEGR.
	II 041540	II 03★0242			
		II 021109			
		II 03★0243			

	Beschreibung description descripção descrizione description benamning Þopps описанье öskilning leírsláttir опис		mm	OE

51.1043.001.099		a	413 x 203 x 75	OE offers only components	MEKRA
51.1043.002.099		a	413 x 203 x 75	OE offers only components	
51.1044.001.099		b	204 x 209 x 88	OE offers only components	
51.1044.002.099		b	204 x 209 x 88	OE offers only components	
09.1000.200.099		1	250		
19.1043.001.099		a	406 x 199 x 40		
19.1044.001.099		b	199 x 204 x 54		
13.1043.001.000		a	413 x 203 x 47		
13.1044.001.000		b	204 x 209 x 54		
19.1000.101.099		c	387 x 205 x 41	82356810	
19.1000.102.099		d	387 x 205 x 41	82359214	
19.1000.103.099		e	205 x 205 x 55	82356824	

VOLVO FH 4
VOLVO FMX
VOLVO FMD

10/12
10/15
2020

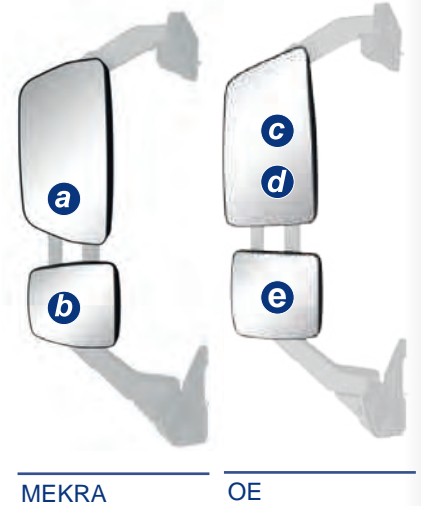

1 Anschlusskabel (Austausch) für Heizung ab Bj. 05/2019
heating cable for replacement for vehicles from 05/2019



VW

349 349 TW	II e1 02★0384	II II			INTEGR.
	II E1 010384				

	Beschreibung description descripção descrizione description benamning Þopps описанье öskilning leírsláttir опис		mm	OE

51.3495.110H			283 x 295 x 80	2D1 857 501 A 01C	1
15.3491.071H			238 x 142 x 6	2D0 857 521	
51.3495.120H			283 x 340 x 80	2D1 857 502 A 01C	1
15.3491.072H			238 x 142 x 6	2D0 857 522	
51.3495.112H			283 x 295 x 80	2D1 857 501 C 01C	1
15.3491.371H			238 x 142 x 6	2D0 857 521 A	
51.3495.122H			283 x 340 x 80	2D1 857 502 C 01C	1
15.3491.372H			238 x 142 x 6	2D0 857 522 A	
56.3491.110H			175 x 116 x 70		2
15.2711.214H			165 x 93 x 15		
56.3492.110H			175 x 116 x 70		2
15.2711.214H			165 x 93 x 15		

01/96

VW



Volkswagen LT (Crafter) 05/2006



589	II III e1 03★0006 II III E1 020902			INTEGR.
------------	---------------------------------------	---	---	----------------









































mm







* mit beheizter Weitwinkel - Glaseinheit, nur verwendbar für Fahrzeuge ab "EURO 5" with heated wide angle mirror glass unit, suitable from "EURO 5" vehicles only

		Beschreibung description description description benamning popsis ömrcauwe öurellik öpis			
L H D	1	51.5891.111.199		344 x 315 x 182	2E1 857 501 E 2E1 857 501 AJ
		51.5891.112.199 *		344 x 315 x 182	2E1 857 501 Q
		51.5891.113.199		344 x 315 x 182	2E1 857 501 F
		51.5891.114.199 *		344 x 315 x 182	2E3 857 501 J
R H D		51.5894.112.199 *		344 x 315 x 182	2E0 857 513 C
		51.5891.311.199		344 x 345 x 182	2E2 857 501 C 2E2 857 501 N
		51.5894.310.199		344 x 345 x 182	2E0 857 513 B
		51.5891.312.199 *		344 x 345 x 182	2E2 857 501 F
L H D		51.5891.313.199		344 x 345 x 182	2E2 857 501 D
		51.5891.314.199 *		344 x 345 x 182	2E4 857 501 K
		51.5891.211.199		344 x 345 x 182	2E1 857 502 E 2E1 857 502 AK
		51.5891.212.199 *		344 x 345 x 182	2E1 857 502 P
R H D		51.5891.213.199		344 x 345 x 182	2E1 857 502 F
		51.5891.214.199 *		344 x 345 x 182	2E3 857 502 K
		51.5894.212.199 *		344 x 345 x 182	2E0 857 514 B
		51.5891.411.199		344 x 315 x 182	2E2 857 502 C 2E2 857 502 N
L H D		51.5894.410.199		344 x 315 x 182	2E0 857 514 A
		51.5891.412.199 *		344 x 315 x 182	2E2 857 502 F
		51.5891.413.199		344 x 315 x 182	2E2 857 502 D
		51.5891.414.199 *		344 x 315 x 182	2E4 857 502 L
L H D	2	51.5892.111.199		344 x 509 x 182	2E3 857 501 D 2E1 857 501 AK
		51.5892.112.199 *		344 x 509 x 182	2E1 857 501 R
		51.5892.113.199		344 x 509 x 182	2E3 857 501 F
		51.5892.311.199		344 x 460 x 182	2E4 857 501 D 2E4 857 501 AD
R H D		51.5892.312.199 *		344 x 460 x 182	2E2 857 501 G
		51.5892.313.199		344 x 460 x 182	2E4 857 501 F
		51.5895.312.199 *		344 x 460 x 182	2E4 857 513 B
		51.5892.211.199		344 x 460 x 182	2E1 857 502 D 2E1 857 502 AL
L H D		51.5892.212.199 *		344 x 460 x 182	2E1 857 502 Q
		51.5892.213.199		344 x 460 x 182	2E3 857 502 F
		51.5892.411.199		344 x 509 x 182	2E4 857 502 E
		51.5892.413.199		344 x 509 x 182	2E4 857 502 G
R H D		51.5895.412.199 *		344 x 509 x 182	2E4 857 514 B
	3	51.5893.111.199		344 x 543 x 182	2E3 857 501 E 2E1 857 501 AL
		51.5893.112.199 *		344 x 543 x 182	2E3 857 501 H
		51.5893.113.199		344 x 543 x 182	2E3 857 501 G
L H D		51.5893.211.199		344 x 511 x 182	2E3 857 502 E 2E1 857 502 AM
		51.5893.212.199 *		344 x 511 x 182	2E3 857 502 J
		51.5893.213.199		344 x 511 x 182	2E3 857 502 G

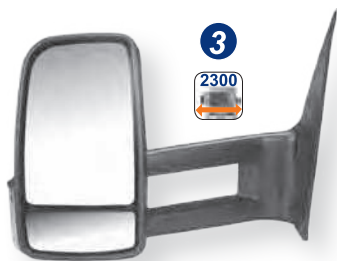



589	II III e1 03★0006		
	II III E1 020902		

	Beschreibung description descripção descrizione description benamining Pops omicaawe birelik letrals opts		OE
--	---	--	----

15.5891.741H		236 x 155 x 16	2E1 857 587	a
15.5891.742H		236 x 155 x 16	2E1 857 588	
15.5891.611H		154 x 59 x 19	2E1 857 587 A	b
15.5891.612H		154 x 59 x 19	2E1 857 588 A	
19.5890.011.099		240 x 158 x 21	2E0 857 587 A	c
19.5890.012.099		240 x 158 x 21	2E0 857 588 A	
19.5891.011.099		240 x 158 x 21	2E0 857 587 B	d
19.5891.012.099		240 x 158 x 21	2E0 857 588 B	
08.5890.300.099		113 x 32 x 15	2E0 919 473	d
08.5890.301.099		113 x 32 x 15	2E0 919 473 A	
15.5891.721.099		157 x 65 x 20	2E1 857 587 E	d
15.5891.722.099		157 x 65 x 20	2E1 857 588 E	
13.5890.110.199		344 x 218 x 82	2E1 857 516 A	c
13.5890.210.199		344 x 218 x 82	2E1 857 516 B	
13.5890.120.099		344 x 201 x 82	2E0 857 527	c
13.5890.220.099		344 x 201 x 82	2E0 857 528	
14.5890.100.099		337 x 192 x 56	2E1 857 136	d
14.5890.200.099		337 x 192 x 56	2E1 857 136 A	
08.5892.001.099		13 133 x 118 x 88	2E0 953 049 A + 2E0 945 981	d
08.5892.002.099		13 133 x 118 x 88	2E0 953 049 C + 2E0 945 981	
08.5892.003.099		13 133 x 118 x 88	2E0 953 050 A or 2E0 953 050 C + 2E0 945 981	d
08.5892.004.099		13 133 x 118 x 88	2E0 953 050 B or 2E0 953 049 B + 2E0 945 981	
08.5892.105.099		12 51 x 27 ø	2E0 945 981	d

Volkswagen LT (Crafter) 05/06 - 09/09



a



b

Volkswagen LT (Crafter) EURO 5 + 6 10/2009



c



d



Volkswagen NF (Crafter) 2017



a



b

1013	NEW	II E1 041427			INTEGR.
-------------	------------	--------------	--	--	---------

	Beschreibung description descripção descrizione description benamining Pops omicaawe birelik letrals opts		OE
--	---	--	----

19.1013.011.099		211 x 169 x 19	VW 7C0 857 521 D VW 7C0 857 521 G	a
19.1013.012.099		211 x 169 x 19	VW 7C0 857 522 A VW 7C0 857 522 F	b

UNIVERSAL

*Agriculture
Case New Holland, Fendt,
John Deere, Kässbohrer, KFB etc.*



* Variante mit 2 Steckern für beheizbare Zusatzspiegel
version with 2 plug sockets for mounting additional heated mirrors

385		II e1 02★0469 I (E1) 010469		Truck II	ABS	① Ø 14-20 mm ② Ø 20-30 mm
MEKRA LANG Group		Beschreibung description description description benämning popis оригинал üzetiik leírás opis		mm		OE
51.3850.127H		314 x 228 x 65	G 297.810.150.030 (Fendt) AL158964 (John Deere)			
51.3850.227		314 x 228 x 65	00437650 (Case New Holland)			
40.2890.222H		300 x 214 x 3	F 297 810 150 010 (Fendt)			
51.3850.137		314 x 228 x 65				
40.2890.322		300 x 214 x 3				
10.6211.100		282 x 162				
09.2000.301H		2000 x 9ø				
51.3850.147H		314 x 228 x 65	Y07001023 (KFB) HJ24013370 (VDL)			
51.3850.247		314 x 228 x 65	8.688.100.000.0 (Kässbohrer)			
40.2890.422H		300 x 214 x 3				
10.6221.100		282 x 162				
09.2000.301H		2000 x 9ø				
51.3850.157		314 x 228 x 65				
40.2890.322		300 x 214 x 3				
10.6211.100		282 x 162				
51.3850.167H		314 x 228 x 65	D072143 (Bredamenarini)			
51.3850.197H *		314 x 228 x 65	2097 0652 (Volvo)			
51.3850.267		314 x 228 x 65	33.63730-6001 (MAN) D072143 (Bredamenarini)			
40.2890.422H		300 x 214 x 3				
10.6221.100		282 x 162	001 821 00 29 (Mercedes) 8.688.041.029.0 (Setra)			
09.3400.420		2000	1905 564 00 (Neoplan) 161.00.77.2027 (MAN Steyr)			

UNIVERSAL

universal Rampenspiegel

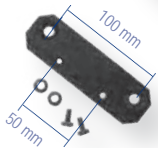

552-1		V VI e1 03★0033 V VI (E1) 020894		Truck V	ABS	
MEKRA LANG Group		Beschreibung description description description benämning popis оригинал üzetiik leírás opis		mm		OE
59.5520.530H		319 x 187 x 77	1525 537 (DAF) 105137C (Plaxton)			

UNIVERSAL

300			① Ø 30 mm ② Ø 35 mm
	Beschreibung description descripção descripção description benamning popis описання őzellik leírás opis		OE
55.3000.001.001		Ø 306 x 96	
55.3000.003.001		Ø 306 x 96	
55.3000.002.001		Ø 306 x 88	
55.3000.004.001		Ø 306 x 88	
51.3000.001.001		Ø 306 x 96	
51.3000.002.001		Ø 306 x 88	2401 8790 (Volvo) 3070159 (SCANIA)
61.3000.003.010		47 x 48 x 260	
61.3000.004.010		47 x 48 x 260	2401 8822 (Volvo) 3070160 (SCANIA)

Innenspiegel Busse
EvoBus, Göppel, Hess, Neoplan,
Scania, VDL, Volvo



750	NEW			INTEGR.
	Beschreibung description descripção descripção description benamning popis описання őzellik leírás opis		OE	
51.7504.044.001		301 x 141	2320 0690 (Volvo)	
20.7504.044.001		230	2328 6290 (Volvo)	
20.7504.003.001		71	2328 6294 (Volvo)	

Innenspiegel



552-1	V VI 03★0033 V VI 020894			INTEGR.
	Beschreibung description descripção descripção description benamning popis описання őzellik leírás opis		OE	
59.5524.530H		418 x 492 x 77	27230912 (Terex)	
51.5524.930H		316 x 186 x 77		

universal Frontspiegel

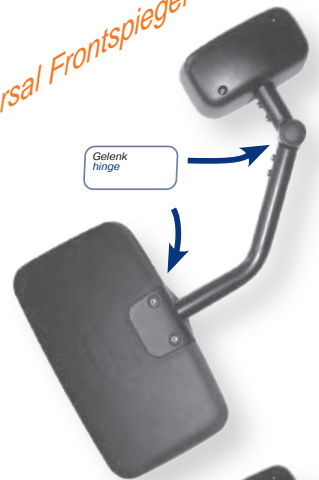

Gelenk
hinge

389	VI 03★0016 VI 020937			INTEGR.
	Beschreibung description descripção descripção description benamning popis описання őzellik leírás opis		OE	
59.3891.140H		397 x 557 x 92		
51.3894.140H		Ø 259 x 92		

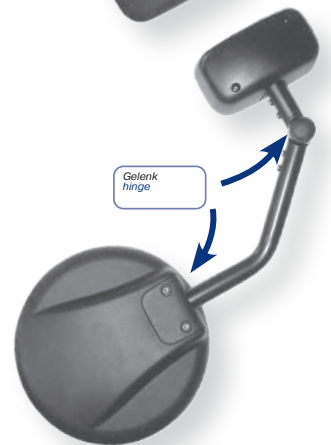

Gelenk
hinge



Montagevarianten
mounting possibilities
possibilités de montage
possibilidades de montagem
variante del montaggio
possibilidades de montaje
monteringsmögijgheter
Montážni varianty
Виды монтажа
montaj montaj olasılıkları
különböző kivitelek
Możliwości montażu

A Dach
roof
pavillon
teto
tetto
techo
tak
střecha automobilu
Крышы автомобиля
kabin üstü
tetöre szerelt
Dach

B A-Säule
A-pillar
montant
pilar A
pilastro A
pilar A
A - stolpe
A - sloupek
A - obr. stolb
A - sütunu
A oszlopra szerelt
Stupek

diverse Traktoren / various tractors



passend für • fitting for • approprié pour • para • adatto per • para • passar • vhodné pro • подходит для • kullanylabilinir • alkalmas • pasuje do

UNIVERSAL AGRICULTURE

152 ASKB	II 14010			Ø 10 / 12 / 13 mm
	Beschreibung description descripção descripziune descripziune benamning popis omicaewie bzeilikk leirras opis			
51.1524.119H		260 x 149 x 22	E 178.810.150.019 (Fendt) E 178.810.150.010 (Fendt) F 178.810.150.020 (Fendt) 000 811 68 33 (Mercedes) 639 153 (Scania)	
40.1525.114H		252 x 141 x 3		

*Steyr Trucks
Steyr- + KHD Traktoren*



289				Ø 16-18 mm
	Beschreibung description descripção descripziune descripziune benamning popis omicaewie bzeilikk leirras opis			
51.2890.117H		310 x 220 x 25	G 816.810.150.030 (Fendt) 161 0077 0103 (MAN Steyr) 81.63730-6170 (MAN)	
40.2890.222H		300 x 214 x 3	F 297 810 150 010 (Fendt)	
51.2890.147H		310 x 220 x 25		
40.2890.422H		300 x 214 x 3		
10.6221.100		282 x 162		
09.2070.101H		2070 x 9ø	10342167 (Liebherr) 11182172 (Liebherr)	

UNIVERSAL

DEMAG, Caterpillar



363	II 03★0022 II 020905			Ø 18-28 mm
	Beschreibung description descripção descripziune descripziune benamning popis omicaewie bzeilikk leirras opis			
51.3635.201		384 x 205 x 120	290-5544 (Caterpillar) 319-6789 (Caterpillar) 270011780 (Krone)	
51.3636.201		384 x 205 x 120	290-5545 (Caterpillar) 319-6788 (Caterpillar)	
51.3635.204		384 x 205 x 120	294-1991 (Caterpillar) 316-6791 (Caterpillar)	
51.3636.204		384 x 205 x 120	294-1992 (Caterpillar) 319-6790 (Caterpillar)	
15.3802.840H		368 x 189 x 40	8.688.105.263.0 (Kässbohrer) 11312890 (Krauss-Maffei) 10470601 (Liebherr) AP105367C-3 (Plaxton) 990115703000 (Tatra) 48092012 (Terex)	
51.3635.206		384 x 205 x 120	688 645 (Fritzmeier) 8.688.105.000.0 (Kässbohrer) 443332051000 (Tatra)	
51.3636.206		384 x 205 x 120	688 646 (Fritzmeier) 8.688.106.000.0 (Kässbohrer) 443332052000 (Tatra)	
15.3802.840H		368 x 189 x 40	<i>siehe oben / see above</i>	
11.3730.210H		367 x 187 x 60	84434473 (CNH)	

UNIVERSAL AGRICULTURE

1009	II (E1) 021165			Ø 18-22 mm Ø 28 mm *
-------------	----------------	--	--	-------------------------

	Beschreibung description description description benamming pops описание betelika letras opis		mm	OE
--	--	--	----	----

51.1009.017.099		382 x 232 x 122	372-8075 (Caterpillar) 26143870 (Class) G304810150020 (Fendt) ACV0805960 (Fendt/Valtra) 42154H3480 (Komatsu) 21D-54-41710 (Komatsu) 1000386860 (Kramer) 11068341 (Liebherr) 3010662 (Lindner) 17452496 (Volvo)	1
51.1009.027.099		382 x 232 x 122	436-2886 (Caterpillar)	
51.1009.149.099		382 x 232 x 122	1000390196 (Kramer) 11181691 (Liebherr) 21971360 (Claas)	
51.1009.097.099		382 x 232 x 122	1000396281 (Kramer) ACV0148490 (Valtra) 3728076-03 (Carwall) ACV0148490 (Fendt) 42154H3380 (Komatsu) 16281990 (Volvo)	
51.1009.025.099		382 x 232 x 122		
51.1009.029.001		382 x 232 x 122		
51.1009.031.001		382 x 232 x 122		
51.1009.045.001		382 x 232 x 122		
51.1009.047.001		382 x 232 x 122		

Große Traktoren
large tractors

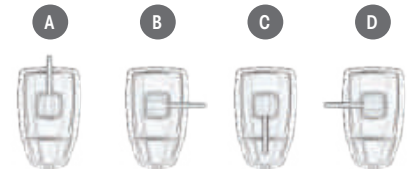

Rohranbindung
mounting position arm



1

Haupt- und Nahbereichsspiegel
Main and close proximity mirror

51.1009.021.099		465 x 231 x 143	26095630 (Claas) G743810150010 (Fendt) 3010850 (Lindner) G743810150020 (Fendt) 26096000 (Claas) 1000379630 (Kramer) 3010851 (Lindner)	2
51.1009.022.099		465 x 231 x 143	3010852 (Lindner)	
51.1009.121.099		465 x 231 x 143	1000379641 (Kramer)	
51.1009.122.099		465 x 231 x 143	3010853 (Lindner)	



2

Hauptspiegel mit großen
Nahbereichsspiegel für
Traktoren ISO 5721-2
Main - and large close proximity
mirror for tractors ISO 5721-2

51.1009.242.099		Ø 28 mm	436-2887 (Caterpillar)	3
09.2000.301H		2000 x 9 Ø	11181692 (Liebherr)	
09.3200.420H		42 x 42 x 54 [2000]	6.200.26.176 (Mauser)	

a	51.1009.001.099		291 x 232 x 121	526-5057 (Caterpillar) 3010115 (Lindner) 2186303 (Wirtgen)
	51.1009.081.099		291 x 232 x 121	3010188 (Lindner)
	51.1009.113.099		291 x 232 x 121	22332170 (Claas) AKK34593 (John Deere)
	51.1009.009.099		291 x 232 x 121	545541 (Miller)
	40.1009.001.000		285 x 225 x 2	5653634836 (Terex) F743810150010 (Fendt)
b	40.1009.004.099		285 x 225 x 2	ACV0759270 (Fendt/ Valtra) 3205677 (Lindner)
	40.1009.001.099		285 x 225 x 2	
	51.1009.049.099		190 x 109 x 18	
	40.1009.002.000		178 x 92 x 2	5653634837 (Terex) F304810150030 (Fendt)
c	40.1009.002.099		178 x 92 x 2	11578550 (Claas) ACV0759280 (Valtra)
	40.1009.005.099		178 x 92 x 2	166352077 (SIAC)
	61.1009.001.099		196 x 188 x 42	11654110 (Claas)
	61.1009.002.099		196 x 188 x 42	11654120 (Claas)
	40.1009.401.000		180 x 170 x 2	
d	40.1009.402.000		180 x 170 x 2	
	40.1009.003.099		202 x 138 x 3	



3

Hauptspiegel mit großen
Nahbereichsspiegel für
Radbagger ISO14401-2
Main - and large close proximity
mirror for Wheel excavator
ISO14401-2

UNIVERSAL AGRICULTURE

*Kleine Traktoren
small tractors*



1010	II (E1) 021228			Ø 14 - 22 mm
	Beschreibung description descripção descrizione descripción benamning popis omicaune üzeylik opis			
51.1010.010.001		284 x 176 x 90	R561145311 (Kubota)	
40.1010.002.099		278 x 169 x 2		

*Teleskopstange
telescopic bracket*



1017			Ø 22 mm
	Beschreibung description descripção descrizione descripción benamning popis omicaune üzeylik opis		
58.1017.005.099		510 - 800 Teleskop	G-530810150010 (AGCO)
58.1017.006.099		510 - 800 Teleskop	G-530810150020 (AGCO)
58.1017.013.099		510 - 800 Teleskop	
58.1017.014.099		510 - 800 Teleskop	
58.1017.011.099		510 - 800 Teleskop	3009961 (Lindner)
58.1017.012.099		510 - 800 Teleskop	3009999 (Lindner)
58.1017.015.099		510 - 760 Teleskop	
58.1017.016.099		510 - 760 Teleskop	

UNIVERSAL

*Teleskop - System
telescopic system*



1017+1009	II (E1) 021165			INTEGR.
	Beschreibung description descripção descrizione descripción benamning popis omicaune üzeylik opis			
59.1017.003.099		505 x 543 -> 833		
59.1017.004.099		505 x 543 -> 833		
59.1017.005.099		505 x 543 -> 833	LF 194 (Amazonen)	
59.1017.006.099		505 x 543 -> 833	LF 195 (Amazonen)	
59.1017.009.099		505 x 543 -> 833		
59.1017.008.099		505 x 543 -> 833		
59.1017.018.001		505 x 543 -> 833		
59.1017.019.001		505 x 543 -> 833		

UNIVERSAL AGRICULTURE

1036

II (E1) 041459



Ø 22 mm



Beschreibung
description
description
description
benamining
popsis
описание
betrijf
letras
opis



51.1036.021.099		487 x 228 x 130		1
51.1036.022.099		487 x 228 x 130		
51.1036.023.099		487 x 228 x 130	26079370 (Claas) 47826941 (CNH)	
51.1036.024.099		487 x 228 x 130	26079500 (Claas) 47904843 (CNH)	
51.1036.025.099		487 x 228 x 130	6-200.26.185 (Mauser)	
51.1036.026.099		487 x 228 x 130		
11.1036.011.099		153 x 144 x 45	11617700 (Claas) 51487075 (CNH) R566924 (John Deere)	
11.1036.012.099		153 x 144 x 45	11617720 (Claas) 51487076 (CNH)	
51.1036.007.099		487 x 228 x 130	47922743 (CNH)	2
51.1036.008.099		487 x 228 x 130	47922744 (CNH)	
51.1036.009.099		487 x 228 x 130	47922739 (CNH) AL232743 (John Deere)	
51.1036.010.099		487 x 228 x 130	47922741 (CNH) AL232744 (John Deere)	
11.1036.013.099		153 x 144 x 45	48025212 (CNH) L221136 (John Deere)	
11.1036.014.099		153 x 144 x 45	48025217 (CNH) L221137 (John Deere)	
19.1036.005.099		299 x 202 x 24	48025196 (CNH)	
19.1036.006.099		177 x 190 x 14	48025209 (CNH)	
19.1036.007.099		299 x 202 x 24	11617730 (Claas) 48025195 (CNH) AL225823 (John Deere)	
19.1036.008.099		177 x 190 x 14	11617740 (Claas) 48025204 (CNH) AL225824 (John Deere)	
19.1036.009.099		299 x 202 x 24		
19.1036.010.099		177 x 190 x 14		
09.3200.420H		42 x 42 x 54 [2000]		

Große Traktoren
large tractors



1

Vertikale Rohranbindung
Mounting to vertical tube



2

Horizontale Rohranbindung
Mounting to horizontal tube



UNIVERSAL MOTOR HOMES

1018

II (E1) 021281

IV (E1) 021282



INTEGR.



Beschreibung
description
descripción
descrizione
benämning
pops
omircauwe
bireilik
leirás
opis



BÜRSTNER Grand Panorama 2012
 → CARTHAGO Chic 2012
 EURA MOBIL Integra 2012
 CONCORDE, Plaxton, Hymer



1	59.1018.003.099		673 x 245 x 327	284260 (Concorde)
	59.1018.004.099		673 x 245 x 327	284261 (Concorde)
	12.1018.003.099		182 x 64 x 61	
2	59.1018.007.099		699 x 245 x 406	2276379 (Bürstner)
	59.1018.008.099		699 x 245 x 406	207193 (Carthago)
	12.1018.005.099		262 x 64 x 64	
3	59.1018.001.099		727 x 245 x 480	200070726B (Eura Mobil)
	59.1018.002.099		727 x 245 x 480	200070727B (Eura Mobil)
	12.1018.007.099		345 x 64 x 67	2193841 (Bürstner) 201621 / 201622 (Carthago)
	12.1018.001.099		517 x 197 x 70	2193829 (Bürstner) 201619 (Carthago) 2203 3845 (Volvo)
	12.1018.002.099		517 x 197 x 70	2193831 (Bürstner) 201620 (Carthago) 2203 3846 (Volvo)
	15.2780.841F		307 x 177 x 22	8034580 (Hymer)
	19.1018.311.099		178 x 142 x 34	
	19.1018.312.099		178 x 142 x 34	
	12.1018.009.001		226 x 116 x 85	2193839 (Bürstner) 284265 (Concorde) 207195 (Carthago) 175202B-9 (Plaxton)
	12.1018.010.001		226 x 116 x 85	2193840 (Bürstner) 284266 (Concorde) 207196 (Carthago) 175202B-8 (Plaxton)
	09.2910.005.099		3550 x 6 ø	2218519 (Bürstner) 200070749 (Eura Mobil)
	09.2910.002.099		6050 x 6 ø	2218516 (Bürstner) 200070751 (Eura Mobil) 2203 8103 (Volvo)
	08.3200.233H		42 x 42 x 54	200607013 (Bürstner) 112228 (Carthago) 200070818 (Eura Mobil) 1449696 (Hymer) 2092 5244 (Volvo)



UNIVERSAL COACHES

271		II e1 02★0524 II (E1) 010524	Truck	ABS	PU	OE
MEKRA LANG Group		Beschreibung description description descripção descrizione benamining popsis описание birelik leirats opis	mm		OE	
59.2710.401H		703 x 783 x 212	284230 (Concorde) 53-707213-710401 (Merkavim) AA-01976 (Plaxton) P758200126 (VDL) 8350 042502 * 7032 8278 (Volvo)	1		
51.3731.326		384 x 205 x 116	50.06.232.483 (Irisbus) 17294289-0 (Marcopolo) 53-707127-731326 (Merkavim) PAA-01976-1 (Plaxton) 189 3532 (Scania) 1905 503 00 (Solaris) 30022423 (VDL) 7030 9627 * 8706 2719 00059 (Volvo) 8350 035653 (Volvo)	2		
59.2710.402H		701 x 641 x 200	1251 2071 (Carrus) 284232 (Concorde) 53-707213-710402 (Merkavim) 30017729 (VDL) 7302 8283 (Volvo)	3		
51.3732.326		384 x 205 x 116	D072145 (Bredamenarini) 7036 9682 (Carrus) 50.06.232.482 (Irisbus) 17294289-0 (Marcopolo) PAA-01977-1 (Plaxton) 180 5203 + 189 5048 (Scania) 1905-502-00 (Solaris) 8706 2719 00060 (Volvo) 8350 035654 (Volvo)	4		
59.2710.454		701 x 801 x 200	083895B (Plaxton)	3		
51.3731.326		384 x 205 x 116	siehe oben / see above	3		
59.2710.406		701 x 746 x 200	284233 (Concorde) AA-01977 (Plaxton)	4		
51.3732.326		384 x 205 x 116	siehe oben / see above	4		
15.3731.470H		368 x 189 x 40	284248 (Concorde) 425 562 28 (Iveco) PAA-01976-2 (Plaxton) 150 5201 (Scania) 1905 731 470 (Solaris) 30017741 (VDL) 8706 2719 00030 (Volvo)	a		
15.2711.114		165 x 93 x 25	284226 (Concorde) 42545988 (Irisbus) 001 810 60 16 (Mercedes) PAA-01976-3 (Plaxton) 8355 0046556 (Volvo)	b		
15.2712.114		152 x 128 x 23	284228 (Concorde) 42545989 (Irisbus) 001 810 61 16 (Mercedes) PAA-01977-4 (Plaxton) 8350 046557 (Volvo)	c		
15.2712.113F		152 x 128 x 23	7030 60536 (Volvo)	d		
11.3730.210H		367 x 187 x 60	84434473 (CNH) 425 459 90 * 425 562 27 (Iveco) 150 5202 (Scania) 17294287-7 (Marcopolo) 8706 2719 00052 (Volvo) 1905 770 210 (Solaris)			
20.2700.200H		126 x 25 Ø	1299452 (Hymer)			
20.2710.200H*		183 x 181 x 84	17294281 (Marcopolo) AA-01978 * AA-01979 (Plaxton) 7036 0530 * 8350 046433 (Volvo)			
20.2710.111H		183 x 145 x 107	09-37986101-8 (Marcopolo) 8706 2719 00020 (Volvo) 8350 046970 (Volvo)			
20.2710.121		183 x 145 x 107	09-37986101-8 (Marcopolo) 7032 8290 * 033 1121 (Volvo)			
20.2480.213		108 x 50 x 15 [800]	356 810 06 11 (Mercedes) AA-01980 * AA-01981 (Plaxton)			
20.2480.216H		108 x 50 x 15 [2000]	284240 (Concorde) 83.63731-6507 (MAN) 53-750610-208091 (Merkavim) 145 1226 (Scania) 1970-018-000 (Solaris) P759001645 (VDL) 7033 1124 * 8350 046971 (Volvo)			
20.2480.217H		108 x 50 x 15 [5000]	284242 (Concorde) 425 459 85 (Iveco) 81.63731-6470 (MAN) P107424C-10 (Plaxton) 53-707213-480217 (Merkavim) P759001646 (VDL) 7033 1123 7034 8002 (Volvo) 8706 2719 00018 (Volvo) 8350 046432 (Volvo)			

Reisebusse / Coaches:
 Avtobus, BMC, Concorde, Dallavia,
 EvoBus, Euro Coach, Hymer,
 Ikarbus, Irisbus, Marcopolo, MAZ,
 LAZ, Plaxton, TEMSA, Tovarna,
 VDL, Volvo (7500 DD, 7700, 8700,
 City Bus, 9300, 9700, Interregio),
 Wrightbus



* für für pour 59.2710.406
 2 pieces necessary

UNIVERSAL COACHES

291	II (E1) 021203			INTEGR.
	IV (E1) 021207			

	Beschreibung description descrição descripción benámenning popis ömrcauwe breiflik opis		OE
--	---	--	-----------

CAETANOBUS Cobus 3000
 CONCORDE Charisma III
 HESS
 MAN Lion's City
 PLAXTON Panther
 PLAXTON Elite
 PLAXTON R9700
 RUNIRAN R9700
 TEMSA Safir
 TEMSA Safir
 TEMSA MD 9
 VISEON C-Serie
 Volvo 9700 / 9900
 VDL Futura

01/2012
 08/2012
 01/2011
 10/2012
 2011
 10/2010
 05/2011
 06/2011
 10/2011

1	59.2910.001.001		1196 x 696 x 239	284215 (Concorde) 5053-APA-06Y (TEMSA) 44.17604-0317 (Viseon) 2187 9369 (Volvo)
	59.2910.002.001		1196 x 696 x 239	284216 (Concorde) 5053-APA-04Y (TEMSA) 44.17604-0318 (Viseon) 2189 4545 (Volvo)
	59.2910.012.001		1196 x 696 x 239	
	59.2910.019.001		1196 x 696 x 239	203722 (Carthago)
	59.2910.020.001		1196 x 696 x 239	203723 (Carthago)
	59.2910.009.001		1196 x 969 x 239	AP140857C-1 (Plaxton)
	59.2910.010.001		1196 x 696 x 239	AP119170C-2 (Plaxton) MD301145Y (TEMSA)
	59.2910.005.001		1196 x 696 x 239	2202 6968 (Carrus)
	59.2910.006.001		1196 x 696 x 239	
	59.2910.015.001		1196 x 696 x 239	22360737 (Volvo)
	59.2910.016.001		1196 x 696 x 239	22360738 (Volvo)
	2	59.2910.003.001		1196 x 696 x 239
59.2910.004.001			1196 x 696 x 239	HD301144Y (TEMSA) 44.17604-0322 (Viseon) 2187 9404 (Volvo)
59.2910.017.001			1196 x 696 x 239	158388C (Plaxton)
59.2910.018.001			1196 x 696 x 239	158396C (Plaxton)
59.2910.007.001		1196 x 696 x 239		
59.2910.008.001		1196 x 696 x 239	2202 6977 (Volvo)	
3	59.2910.013.001		1196 x 696 x 239	248268 (Concorde)
	59.2910.014.001		1196 x 696 x 239	248269 (Concorde)

1
 Spiegel mit HS, WWS
 mirror with HS, WWS



2
 Spiegel mit HS und Bugspiegel
 mirror with HS and front crossview mirror



3
 Spiegel mit HS, WWS und ZS (links)
 mirror with HS, WWS and ZS (left)



4
 Spiegel mit HS, WWS und NBS (rechts)
 mirror with HS, WWS and NBS (right)

UNIVERSAL

UNIVERSAL COACHES

291	II (E1) 021203			INTEGR.
	IV (E1) 021207			

	Beschreibung description descripción descrizione description beschrijving ovrrecaune överlägg opis		
--	--	--	--

61.2910.001.001		262 x 150		3
61.2910.002.001		262 x 150	22117455 (Volvo)	
61.2910.003.001		312 x 150	5053-APA-05Y (Temsas)	4
61.2910.004.001		312 x 150	5053-APA-03Y (Temsas)	
61.2910.007.001	(with LED)	312 x 150	22117457 (Volvo)	5
61.2910.008.001	(with LED)	312 x 150	21885965 (Volvo)	
61.2910.005.001		412 x 150	HD 301152 (Temsas)	5
61.2910.006.001		412 x 150	HD 301151 (Temsas)	
61.2910.021.001		412 x 150	284217 (Concorde)	5
61.2910.022.001		412 x 150	284218 (Concorde)	
09.2910.007.000		1050 x 6 ø		5
09.2910.004.099		2750 x 6 ø	201931 (Carthago)	
09.2910.005.099		3550 x 6 ø	2218519 (Bürstner) 200070749 (Eura Mobil)	5
09.2910.002.099		6050 x 6 ø	2218516 (Bürstner) 284221 (Concorde) 200070751 (Eura Mobil) 44.15240-0300 (Viseon) 2203 8103 (Volvo)	
09.2910.003.099	(for LED or)	6050 x 6 ø	22212554 (Volvo)	5
09.2770.001.000		6050 x 6 ø		
08.3200.233H		42 x 42 x 54	20925244 (Volvo)	

CAETANOBUS Cobus 3000 01/2012
 CONCORDE Charisma III 08/2012
 HESS 10/2011
 MAN Lion's City 10/2012
 PLAXTON Panther 2011
 PLAXTON Elite 10/2010
 RUNIRAN R9700 05/2011
 TEMSA Safari 06/2011
 TEMSA MD 9 10/2011
 VISEON C-Serie
 Volvo 9700 / 9900
 VDL Futura

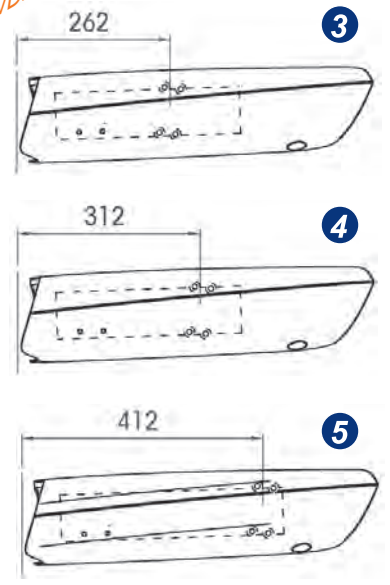

15.2780.840		307 x 177 x 22	81.63733-0113 (MAN) P119170C-8 (Plaxton) 5053-APA-04-01Y (TEMSA) 30017846 (VDL) 48.17600-0026 (Viseon)
15.2780.841F		307 x 177 x 22	201932 (Carthago)
19.2910.001.099		184 x 154 x 31	P119170C-7 (Plaxton) 5053-APA-04-03Y (TEMSA)
19.2910.002.099		184 x 172 x 39	HD301144-02Y (TEMSA)
08.3950.001.099	Control Unit for	40 x 30 x 30	22038110 (Volvo)
08.2910.001.002	LED		22488075 (Volvo)
61.5590.001.099	for 3 and 4	256 x 165 x 82	
11.2910.001.000	für für pour	597 x 105 x 66	back
11.2910.002.000	für für pour	617 x 112 x 105	back
11.2910.003.000	für für pour	651 x 112 x 146	front
11.2910.004.000	für für pour	509 x 112 x 123	front
11.2910.006.000	für für pour	597 x 105 x 66	back
11.2910.007.000	für für pour	617 x 112 x 105	back
11.2910.008.000	für für pour	651 x 112 x 146	front
11.2910.009.000	für für pour	509 x 112 x 123	front
11.2910.011.002	für für pour	514 x 225 x 121	
11.2910.012.002	für für pour	514 x 225 x 121	

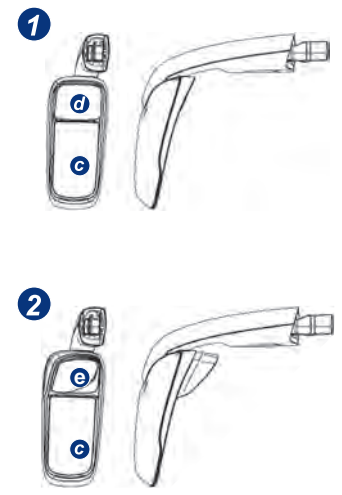

UNIVERSAL

Heizkabel mit Steckanschluss
Heating cable with plug



Steuerkabel
control cable



UNIVERSAL ACCESSORIES

MEKRA LANG Group	Beschreibung description description description description beniänimning popis omicaavne üzellik leirás opis						mm	OE
09.2070.101H							2070 x 9ø	
09.2000.301H							2000 x 9ø	

MEKRA LANG Group	Beschreibung description description description description beniänimning popis omicaavne üzellik leirás opis						mm	OE
09.3200.320H	2 Typ 320 Typ 363 Typ 373 Typ 0.381 Typ 1009 Typ 340 Typ 330 Typ 385						2000 x 6ø	
09.3300.421	2 Typ 330 Typ 340 Typ 385						2000 x 6ø	









MEKRA LANG Group	Beschreibung description description description description beniänimning popis omicaavne üzellik leirás opis						mm	OE
08.3200.233H	2 12V 24V						42 x 42 x 54	

MEKRA LANG Group	Beschreibung description description description description beniänimning popis omicaavne üzellik leirás opis						mm	OE
09.3200.420H	2 Typ 320 Typ 363 Typ 373 Typ 0.381 Typ 1009						42 x 42 x 54 [2000]	
08.3200.233H	2 12V 24V						42 x 42 x 54	
09.3200.220	6.3						1000	
09.3200.320H	2						2000 x 6ø	
09.3400.420	2 Typ 330 Typ 340 Typ 385						42 x 42 x 54 [2000]	
08.3200.233H	2 12V 24V						42 x 42 x 54	
09.3200.220	6.3						1000	
09.3200.320H	2						2000	
09.3300.421	2						2000	

UNIVERSAL

UNIVERSAL ACCESSORIES



248/2 A

		Beschreibung description description description description benámening popis описанье özellik leirás opis	 mm	
20.2480.210H			108 x 50 x 15	5571298 (Bomag) D067504 (Bredamenarini) 218 142 (Fritzmeier) 84433427 (Case New Holland) 7621216 (Liebherr) 17294377-6 (Marcopolo) 671 811 0111 (Mercedes) P105367C-15 (Plaxton) 144 8217 (Scania) 7035 2646 (Volvo) 8706 2719 00055 (Volvo)
20.2480.211H			108 x 50 x 15 [2500]	145 1227 (Scania) 1990-685-650 (Solaris) 2085 4088 (Volvo) 8350 003620 (Volvo)
20.2480.223			108 x 50 x 15 [150]	81.63731-6478 (MAN) 17294378-2 (Marcopolo) 2051 5454 (Volvo) 8706 2719 00040 (Volvo)
20.2480.213			108 x 50 x 15 [800]	356 810 06 11 (Mercedes) AA-01980 / AA-01981 (Plaxton)
20.2480.216H			108 x 50 x 15 [2000]	284240 (Concorde) VI-10-01-010 (Eura Mobil) R21640 (Lahden) 83.63731-6507 (MAN) 53-750610-208091 (Merkavim) 145 1226 (Scania) 1970-018-000 (Solaris) P759001645 (VDL) 7033 1124 / 8350 046971 (Volvo) 284242 (Concorde) 425 45985 (Iveco) 77037873 (Komatsu)
20.2480.217H			108 x 50 x 15 [5000]	R21645 (Lahden) 81.63731-6470 (MAN) 53-7072 13-480217 (Merkavim) P107424C-10 (Plaxton) P759001646 (VDL) 7033 1123 / 7034 8002 (Volvo) 8350 046432 / 8706 2719 00018 (Volvo)

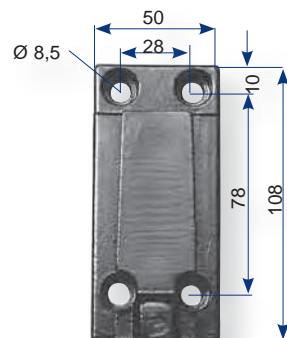
Aufsteckkeile
Mounting wedges



271 A

		Beschreibung description description description description benámening popis описанье özellik leirás opis	 mm	
20.2710.620			124 x 59 x 21 [500]	200083489 (Eura Mobil) 50.00.021.163 (Irisbus) 17042340N0000 (Krauss-Maffei) 53-7072 13-710620 (Merkavim) 7033 1941 (Volvo)

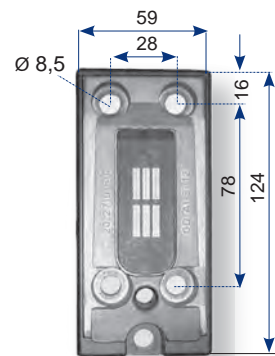

UNIVERSAL

UNIVERSAL AGRICULTURE

1016



Ø 22 mm

MEKRA
LANG Group
 Beschreibung
 description
 descrição
 descrizione
 descripción
 benámenning
 popis
 описание
 özeňlik
 apris

OE

Haltestangen brackets



U-Form
U-shape

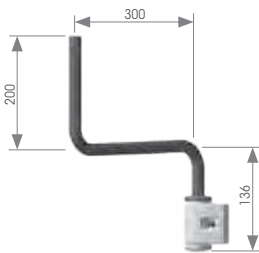

Z-Form
Z-shape

U	58.1016.001.099		200 x 230 x 136
	58.1016.002.099		200 x 230 x 136
	58.1016.003.099		200 x 230 x 136
	58.1016.004.099		200 x 230 x 136
Z	58.1016.005.099		336 x 300
	58.1016.006.099		336 x 300
	20.1016.004.000	Sechskant hex attachment for	

Manuell verstellbar in 30°-Stufen

Manually adjustable in steps of 30°

Montage von Innenseite Fahrzeug verschraubt (Variante 2) oder von außen mittels Sechskant verschweißt (Variante 1) möglich

Mounting base bolted through hex attachment (Version 1) or directly bolted from vehicle side (Version 2)

Sowohl hängend als auch stehend montierbar (Darstellung: stehend)

Tube can be turned upside down hanging and standing (Shown: standing)

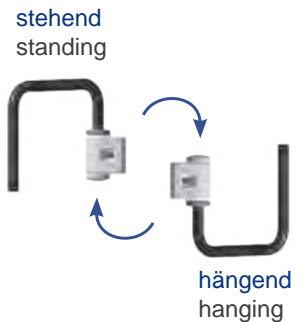

Montage von Außenseite Fahrzeug verschweißt
Mounting base bolted through hex attachment

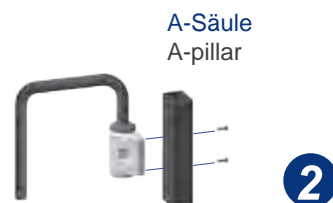

Montage von Innenseite Fahrzeug verschraubt
Mounting directly bolted from vehicle side

UNIVERSAL BUSES

270 A				st		Ø 28 mm	
MEKRA LANG Group		Beschreibung description descripción descrizione description benámenning Pops описаније ბრელიკი letraks opis		mm		OE	
58.2704.051H			90°	270 x 464 x 28 ø	0783032 (Dethleffs) 1905-509-025 (Solaris)	1	
58.2704.048			90°	216 x 514 x 28 ø	HEO 627 810 M1 47 (EvoBus) 3600100512654 (Evobus) 1905-508-000 (Solaris) 0000-217-083 (Solaris) 7032 8298 (Volvo) 7033 1060 (Volvo) 2053 5857 (Volvo)	2	
58.2704.044			90°	216 x 514 x 28 ø	7032 8298 (Volvo) 7033 1060 (Volvo) 2053 5857 (Volvo)		
58.2704.088			120°	216 x 514 x 28 ø	50.06.232.165 (Irisbus)		
58.2704.070			6°	732 x 327 x 28 ø	1905-509-000 (Solaris) 7032 8294 (Volvo)	3	
58.2704.086			6°	732 x 327 x 28 ø	1905 500 010 (Solaris) 2056 4284 (Volvo)		
58.2704.093			6°	732 x 327 x 28 ø	1905-506-010 (Solaris)		
58.2705.003			17°	668 x 350 x 28 ø	7035 2000 (Volvo)	4	
58.2705.001H			17°	668 x 350 x 28 ø	7030 9620 (Volvo) 8706 2719 00056 (Volvo) VG10037.000 (Volvo)		
61.2708.842H					150 5203 (Scania)		
61.2703.110			128°	156 x 129 x 36	000 810 04 12 (Mercedes)		
61.2703.120			56°	156 x 129 x 36	000 810 05 12 (Mercedes)		

Haltestangen brackets

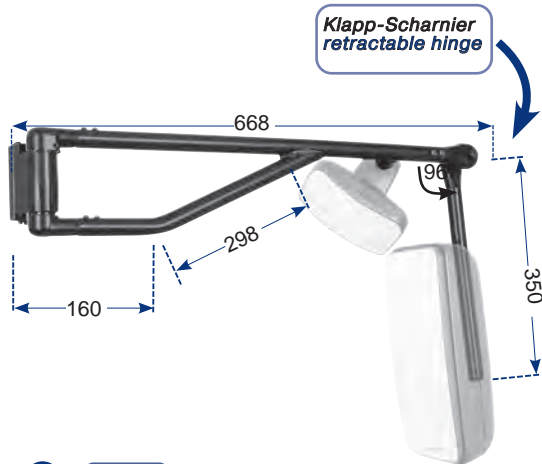
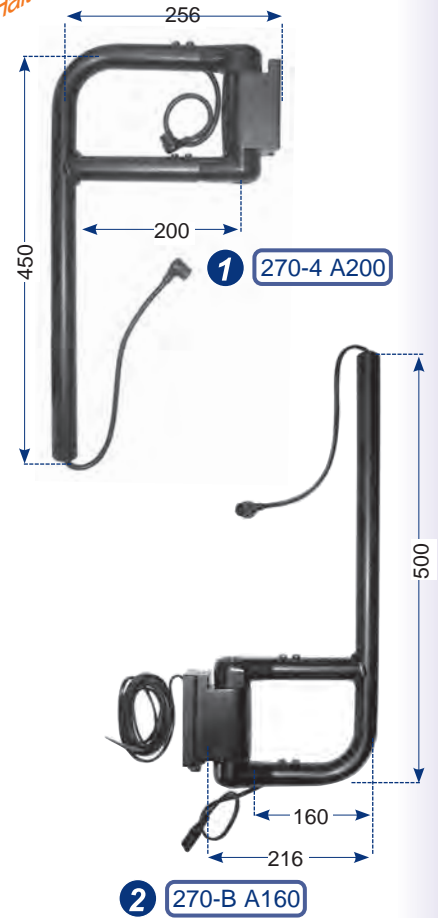

4 270-5

Klappstange
hinged tube

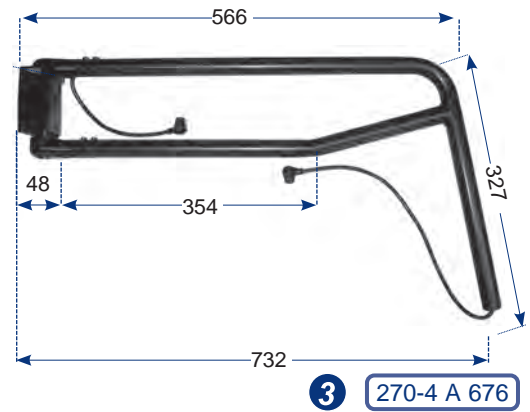

3 270-4 A 676



UNIVERSAL

ALLGEMEINE GESCHÄFTSBEDINGUNGEN (AGB)

I. Allgemeine Bedingungen

Den Vertragsbeziehungen zwischen uns, MEKRA Lang GmbH & Co. KG („MEKRA Lang“), und unseren Bestellern, die Unternehmer im Sinne des § 14 BGB sind, liegen ausschließlich die nachfolgenden AGB zugrunde. Abweichende Geschäftsbedingungen des Bestellers werden, selbst bei Kenntnis, nicht Vertragsbestandteil. Unsere Angebote sind stets freibleibend. Unsere AGB gelten mit der Auftragserteilung, spätestens mit der Annahme der Ware als anerkannt. Diese AGB gelten bei ständigen Geschäftsbeziehungen auch für alle künftigen Geschäfte. Sollten einzelne Bestimmungen ganz oder teilweise unwirksam sein oder werden, so wird hierdurch die Gültigkeit der übrigen Bestimmungen nicht berührt. In diesem Fall werden MEKRA Lang und der Besteller eine Regelung vereinbaren, deren wirtschaftlicher Erfolg dem der unwirksamen Regelung möglichst nahe kommt. Bis dahin gilt die Gesetzestexte.

II. Vertragsschluss und Preise

- Mit der Bestellung einer Ware erklärt der Besteller verbindlich, die bestellte Ware erwerben zu wollen. Er ist an diese Erklärung zwei Wochen gebunden. Wir sind berechtigt, das in der Bestellung liegende Vertragsangebot innerhalb von zwei Wochen nach Eingang bei uns anzunehmen. Die Annahme kann schriftlich, elektronisch oder durch Auslieferung der Ware an den Besteller erklärt werden.
- Die Verpflichtungen im elektronischen Geschäftsverkehr gem. § 312e Abs. 1 Satz 1 Nr. 1 bis 3 und Satz 2 BGB werden ausgeschlossen.
- Der Vertragsschluss erfolgt unter dem Vorbehalt der richtigen und rechtzeitigen Selbstbelieferung durch unsere Zulieferer. Dies gilt nur für den Fall, dass die Nichtbelieferung nicht von uns zu vertreten ist, insbesondere bei Abschluss eines kongruenten Deckungsgeschäftes mit unseren Zulieferern. Der Besteller wird über die Nichtverfügbarkeit der Leistung unverzüglich informiert und die Gegenleistung, soweit bereits geleistet, unverzüglich zurückerstattet.
- Alle vertraglichen Zahlungsverpflichtungen sind ausschließlich in EURO zu erfüllen.
- Die Preise verstehen sich netto ab Werk bzw. Auslieferungslager. Fracht-, Verpackungs-, Einfuhrkosten, Zoll und sonstige Nebenabgaben gehen zu Lasten des Bestellers.

III. Lieferzeit und Lieferverpflichtung

- Für Umfang, Art und Zeitpunkt der Lieferung ist unsere schriftliche oder elektronische Auftragsbestätigung maßgebend. Teil-Lieferungen sind zulässig.
- Eine Verpflichtung zur Einhaltung als verbindlich bezeichneter Lieferfristen wird nur unter der Voraussetzung eines ungestörten Betriebs- und Vertriebsablaufs übernommen; insbesondere in Fällen höherer Gewalt und sonstiger störender Ereignisse bei uns, bei unseren Lieferanten oder bei den Transportunternehmern, beispielsweise Betriebs- oder Verkehrsstörungen, Feuer, Überschemmungen, Arbeitskräfte-, Energie- oder Verkehrsmangel, Streik, Aussperrung, behördliche Maßnahmen sowie technische oder technologische Umstände, welche die Auftragsausführung wesentlich erschweren, entbinden uns von der Pflicht zur rechtzeitigen Lieferung oder geben uns das Recht, unsere Lieferung ohne Nachlieferpflicht einzustellen.
- Sofern nichts Abweichendes vereinbart ist, sind wir berechtigt, bereits vor einem genannten Liefertermin zu leisten. Ebenso gilt, sofern nichts Abweichendes vereinbart ist, eine bis maximal zwei Wochen über einem genannten Liefertermin liegende Leistung unsererseits nicht als verspätet.
- Lieferfristen gelten als eingehalten, wenn bis zu ihrem Ablauf die Ware das Werk oder Auslieferungslager verlassen hat oder dem Besteller die Anzeige unserer Versandbereitschaft zugegangen ist. Nachträgliche Änderungen des Vertrages verlängern die Lieferfristen angemessen.
- Bei Verträgen, deren Erfüllung aus mehreren Lieferungen besteht, ist Nichterfüllung, oder mangelhafte oder verspätete Erfüllung einer Lieferung ohne Einfluss auf andere Lieferungen aus dem Vertrag.
- Zahlungsverzug, die Abgabe einer eidesstattlichen Offenbarungsversicherung gemäß § 807 ZPO, eintretende Zahlungsschwierigkeiten oder das Bekanntwerden einer wesentlichen Verschlechterung der Vermögensverhältnisse des Bestellers berechtigen uns nach unserer Wahl, für noch offenstehende Lieferungen Vorauszahlung zu verlangen oder Lieferungen sofort einzustellen und die Erfüllung laufender Verträge zu verweigern. Gleichzeitig sind wir berechtigt, noch nicht fällige Forderungen gegen den Besteller sofort fällig zu stellen.

IV. Versand, Gefahrenübergang

- Verpackung, Versandweg und Transportmittel sind unserer Wahl überlassen, es sei denn, es ist zwischen den Parteien etwas anderes vereinbart.
- Die Gefahr des zufälligen Untergangs und der zufälligen Verschlechterung der Ware geht mit der Übergabe, beim Verkauf mit der Auslieferung der Sache an den Spediteur, den Frachtführer oder der sonst zur Ausführung der Versendung bestimmten Person oder Anstalt, auf den Besteller über. Der Übergabe steht es gleich, wenn der Besteller im Verzug der Annahme ist.
- Ware aus Abrufaufträgen ist, wenn nicht anders vereinbart, innerhalb von 3 Monaten nach Erteilung der Auftragsbestätigung abzunehmen.
- Versicherung gegen Bruch- und Transportrisiken werden nur auf besonderen Wunsch gegen Berechnung der Kosten übernommen.
- Zoll und sonstige Spesen, auch die Unkosten für Bezahlung der zur Einfuhr in das Bestimmungsland notwendigen Papiere, gehen zu Lasten des Käufers.

V. Zahlung, Zahlungsbedingungen

- Rechnungen sind zahlbar:
 - innerhalb von 14 Tagen ab Rechnungsdatum mit 2 % Skonto vom Rechnungswert.
 - innerhalb von 30 Tagen ab Rechnungsdatum ohne Skonto vom Rechnungswert.
- Kassa - Skonto wird nur gewährt, wenn sämtliche Zahlungsverpflichtungen aus früheren Lieferungen erfüllt sind und der Rechnungsbetrag punktilich bis zu den vorgeannten Fälligkeitstagen bei uns in bar vorliegt oder unserem Konto gutgeschrieben ist. Wechselheringabe kann also nicht zur Gewährung von Kassa -Skonto führen. Bei bargeldloser Zahlung, insbesondere auch bei Scheckheringabe, kommt es auf den Zeitpunkt

der Gutschrift an. Bei Zahlung oder Gutschrift unter Vorbehalt, unter einer Bedingung oder sonstigen Einschränkungen kann Skonto nicht gewährt werden. Das Risiko des Zahlungsweges trägt der Besteller. Rechnungen für Werkzeuge sind ohne Skontoabzug sofort zahlbar.

- Die Annahme von Wechseln und Schecks erfolgt nur erfüllungshalber. Entsprechende Gutschriften erfolgen nur unter Vorbehalt des Einganges des vollen Betrages. Die Hereinnahme von fremden oder eigenen Akzepten behalten wir uns vor. Kosten und Diskontspesen gehen zu Lasten des Bestellers. Eine Gewähr für Vorlage und Protest übernehmen wir nicht. Protesterhebung eigener Wechsel des Bestellers oder nicht sofortige Abdeckung protestierter Fremdwechsel ermächtigen uns, sämtliche noch laufende Wechsel zurückzugeben. Gleichzeitig sind wir berechtigt, nicht fällige Forderungen gegen den Besteller sofort fällig zu stellen. Vordatierte Schecks werden nicht angenommen.
- Bei Überschreitung des Zahlungstermins werden Verzugszinsen in Höhe von 9 %-Punkten über dem jeweiligen Basiszinssatz gem. § 247 BGB sowie eine Verzugschadenspauschale in Höhe von 40,00 Euro gem. § 288 Abs. 5 BGB fällig. Die Geltendmachung eines weiteren Verzugschadens oder anderer Rechte bleibt vorbehalten.
- Voraus- und Abschlagszahlungen werden nicht verzinst.
- Zur Aufrechnung oder Einbehaltung von Zahlungen ist der Besteller nur berechtigt, wenn seine Gegenforderung unbestritten und rechtskräftig festgestellt ist. Der Besteller kann ein Zurückbehaltungsrecht nur ausüben, wenn sein Gegenanspruch auf demselben Vertragsverhältnis beruht.
- Beim Ausgleich von Rechnungen sind vom Besteller seine Kundennummer und die Rechnungsnummer anzugeben. Verzögerungen oder Fehlbuchungen, die infolge Nichteinhaltung dieser Verpflichtungen eintreten, gehen zu Lasten des Bestellers.

VI. Eigentumsvorbehalt, Factoring

- Die gelieferte Ware bleibt bis zur Bezahlung aller bestehenden Forderungen aus der Geschäftsverbindung mit dem Besteller unser Eigentum. Der Besteller ist im Rahmen des ordnungsgemäßen Geschäftsganges zur Weiterveräußerung der Vorbehaltsware berechtigt; eine Verpfändung oder Sicherungsübereignung ist ihm jedoch nicht gestattet. Bei einem Weiterverkauf von Vorbehaltsware auf Kredit ist er verpflichtet unsere Rechte zu sichern.
- Die Forderungen des Bestellers aus der Weiterveräußerung der Vorbehaltsware tritt dieser schon jetzt in Höhe des Rechnungsbetrages an uns ab; Wir nehmen diese Abtretung an. Ungeachtet der Abtretung ist der Besteller zur Einziehung solange berechtigt, als er seinen Verpflichtungen uns gegenüber aus dem zugrundeliegenden Vertragsverhältnis nachkommt und nicht in Vermögensverfall gerät. Andernfalls hat er auf unser Verlangen die zur Einziehung erforderlichen Angaben über die abgetretene Forderung zu machen und seinen Schuldnern diese Abtretung anzuzeigen. Für diesen Fall behalten wir uns vor, die Forderung selbst einzuziehen.
- Eine etwaige Be- oder Verarbeitung der Vorbehaltsware durch den Besteller erfolgt stets im Namen und im Auftrag für uns, ohne dass uns jedoch Verbindlichkeiten hieraus erwachsen dürfen. Bei der Verarbeitung der Vorbehaltsware mit anderen, uns nicht gebörenden Waren, steht uns der dabei entstandene Miteigentumsanteil an der neuen Sache im Verhältnis des Wertes der Vorbehaltsware zu der übrigen verarbeiteten Ware zu. Soweit hier und auch nachfolgend auf den Wert der Vorbehaltsware abgestellt ist, ergibt sich diese aus unserem Fakturawert.
- Erwirbt der Besteller das Alleineigentum an der neuen Sache gemäß § 947 Abs. 2 BGB, so besteht Einigkeit darüber, dass er uns im Verhältnis des Wertes der verarbeiteten bzw. verbundenen oder vermischten Vorbehaltsware Miteigentum an der neuen Sache einräumt und diese unentgeltlich für uns bewahrt.
- Wird die Vorbehaltsware zusammen mit anderen Waren, und zwar gleichgültig, ob ohne oder nach Verarbeitung, Verbindung oder Vermischung weiter veräußert, so gilt die oben vereinbarte Vorausabtretung nur in Höhe des Wertes der Vorbehaltsware, die zusammen mit den anderen Waren weiterveräußert wird. Wir verpflichten uns, die uns nach den vorstehenden Bestimmungen zustehenden Sicherungen auf Verlangen insoweit freizugeben, als der Wert die zu sichernden Forderungen mit 20 % übersteigt.
- Über Zwangsvollstreckungsmaßnahmen Dritter in die Vorbehaltsware oder die im Voraus abgetretenen Forderungen hat uns der Besteller unverzüglich unter Übergabe der für eine Intervention notwendigen Unterlagen zu unterrichten. Daraus bis uns entstehende Interventionskosten sind vom Besteller zu tragen.
- Der Besteller hat die Vorbehaltsware ausreichend gegen Feuer und Einbruchdiebstahl zu versichern und uns dies auf Verlangen nachzuweisen.

VII. Mängelansprüche

- Die Verjährungsfrist für Mängelansprüche beträgt 24 Monate ab Ablieferung der Ware.
- Wir leisten für Mängel der Ware zunächst nach unserer Wahl Gewähr durch Nachbesserung oder Ersatzlieferung. Bei Fehlschlägen von Nachbesserung oder Ersatzlieferung kann der Besteller Rückgängigmachung des Vertrages oder Herabsetzung der Vergütung verlangen. Bei einer nur geringfügigen Vertragswidrigkeit, insbesondere bei nur geringfügigen Mängeln, steht dem Besteller jedoch kein Rücktrittsrecht zu.
- Der Besteller hat offensichtliche Mängel unverzüglich, spätestens innerhalb von 7 Tagen nach Eingang der Ware unter sofortiger Einstellung etwaiger Bearbeitung schriftlich anzuzeigen. Andernfalls ist die Geltendmachung von Mängelansprüchen ausgeschlossen. Zur Fristwahrung genügt die rechtzeitige Absendung. Den Besteller trifft die volle Beweislast für sämtliche Anspruchsvoraussetzungen, insbesondere für den Mangel selbst, für den Zeitpunkt der Feststellung des Mangels und für die Rechtzeitigkeit der Mängelrüge.
- Mängel, die auch bei sorgfältiger Prüfung innerhalb dieser Frist nicht entdeckt werden können, sind unverzüglich nach Entdeckung schriftlich zu rügen. Wählt der Besteller wegen eines Rechts- oder Sachmangels nach gescheiterter Nacherfüllung den Rücktritt vom Vertrag, so hat er daneben kein Schadensersatzanspruch wegen des Mangels zu.
- Wählt der Besteller nach gescheiterter Nacherfüllung Schadensersatz, verbleibt die Ware beim Besteller, wenn ihm dies zumutbar ist. Der

Schadensersatz beschränkt sich auf die Differenz zwischen Kaufpreis und Wert der mangelhaften Sache. Dies gilt nicht, wenn wir die Vertragsverletzung arglistig verursacht haben.

- Ware, für die wir Ersatz geleistet haben, geht in unser Eigentum über und ist an uns zurückzusenden gegen Kostenerstattung.
- Ansprüche bestehen nicht für solche Schäden, die dadurch entstanden sind, dass der Besteller schuldhaft
 - den Kaufgegenstand unsachgemäß behandelt oder überanspricht hat oder
 - den Kaufgegenstand in einer nicht vereinbarten Weise verändert hat oder
 - die Vorschriften der Montage- oder Betriebsanleitung nicht befolgt hat oder
 - die Rüge- und Zustellungspflicht gemäß vorstehender Ziffer 3 und 4 verletzt hat oder
 - den Kaufgegenstand nach Mangelfeststellung weiterbenutzt hat.
 Natürlicher Verschleiß ist von der Gewährleistung ausgenommen.

VIII. Haftung

- Bei leicht fahrlässigen Pflichtverletzungen beschränkt sich unsere Haftung auf den nach der Art der Ware vorhersehbaren, vertragstypischen, unmittelbaren Durchschnittsschaden. Dies gilt auch bei leicht fahrlässigen Pflichtverletzungen unserer gesetzlichen Vertreter oder Erfüllungsgehilfen. Bei leicht fahrlässiger Verletzung unwesentlicher Vertragspflichten haften wir nicht.
- Die Haftung aufgrund übernommener Garantien sowie aufgrund Produkthaftung bleibt unberührt, ebenso bei uns zurechenbaren Körper- oder Gesundheitsschäden oder bei Verlust des Lebens des Bestellers.
- Schadensersatzansprüche des Bestellers wegen eines Mangels verjähren nach einem Jahr ab Anlieferung der Ware. Dies gilt nicht, wenn uns Vorsatz oder grobes Verschulden vorwerfbar ist, sowie im Falle von uns zurechenbaren Körper- und Gesundheitsschäden oder bei Verlust des Lebens des Bestellers.

IX. Rücknahme

Ordnungsgemäß bestellte und gelieferte Ware wird grundsätzlich nicht zurückgenommen. Ausnahmen bilden Rücknahmen, die mit uns vereinbart wurden. Zusätzlich müssen folgende Voraussetzungen erfüllt werden:

- Die Produkte müssen von uns oder von einem unserer Werkslager direkt bezogen worden sein.
- Einwandfreier und unveränderter Zustand der Ware.
- Rückgabe ist die Rücknahme durch uns nur dann möglich, wenn die zur Rückgabe vorgesehenen Teile noch im Lieferprogramm sind.
- Rückversand muss „frei Haus“ an unser Werk Ergersheim oder an das zuständige Werkslager unter Angabe von Liefererscheindatum und -nummer erfolgen. Wertabschlag bei Rücknahme:
 - im 1. Jahr nach Liefertag *J.* 10 % vom Lieferpreis
 - im 2. Jahr nach Liefertag *J.* 25 % vom Lieferpreis
 - zwischen 3. und 5. Jahr nach Liefertag *J.* 50 % vom Lieferpreis
 - Ware älter als 5 Jahre keine Rücknahme möglich.

Nach Erhalt der Teile erfolgt die technische Überprüfung und Erstellung der Gutschrift unter Berücksichtigung eines etwaigen Wertabschlages. Frachtkosten, sofern sie für den ursprünglichen Versand für uns entstanden sind, vermindern den Restwert.

X. Schutzrechte

- Bei kundenspezifischen Sonderanfertigungen haftet der Besteller uns für die Freiheit von Schutzrechten Dritter der in Auftrag gegebenen Lieferung, stellt uns von etwaigen Ansprüchen Dritter frei und hat uns etwaigen aus einer Verletzung dieser Pflicht resultierenden Schaden zu ersetzen.
- Unsere Entwürfe und Konstruktionsvorschläge sind vertraulich zu behandeln und dürfen nicht an Dritte weitergegeben werden.
- Sämtliche Zeichnungen, Konstruktionspläne und Muster, die dem Besteller zugegangen sind, bleiben unser geistiges Eigentum.

XI. Erfüllungsort, Gerichtsstand, sonstige Vereinbarungen

- Als Beschaffenheit der Ware gilt grundsätzlich nur unsere Produktbeschreibung als vereinbart. Öffentliche Äußerungen, Anpreisungen oder Werbung durch uns stellen daneben keine vertragsgemäße Beschaffenheitsangabe der Ware dar. Proben und Muster gelten als annähernde Anschauungstücke für Qualität, Abmessungen und Farbe. Rechtsansprüche können hieraus nicht abgeleitet werden. Technische Änderungen sowie Änderungen in Form, Farbe und/oder Gewicht bleiben uns im Rahmen des Zumutbaren vorbehalten.
- Erhalt der Besteller eine mangelhafte Montageanleitung, sind wir lediglich zur Lieferung einer mangelfreien Montageanleitung verpflichtet und dies auch nur dann, wenn der Mangel der Montageanleitung der ordnungsgemäßen Montage entgegensteht.
- Garantien im Rechtssinne erhält der Besteller durch uns nicht; Herstellergarantien bleiben hiervon unberührt.
- Erfüllungsort für unsere Lieferungen ist bei Lieferung ab Werk das Lieferwerk, bei Lieferung ab Lager das Lager. Erfüllungsort für alle Zahlungen ist Ergersheim / Bayern, Deutschland.
- Ausschließlicher Gerichtsstand für alle Streitigkeiten aus diesem Vertrag ist Fürth / Bayern, Deutschland. Dies gilt auch für evtl. Scheck- und Wechselklagen.
- Es gilt das Recht der Bundesrepublik Deutschland. Die Bestimmungen des UN-Kaufrechts finden keine Anwendung. Es ist allein der Text der deutschsprachigen Fassung dieser Allgemeinen Geschäftsbedingungen maßgeblich.
- Ergänzend gelten die mit den jeweiligen Preislisten bekannt gegebenen Sonderbedingungen unserer Produkte.
- Der Besteller ist selbst dafür verantwortlich, die Eignung von Waren für den beabsichtigten Verwendungszweck zu prüfen.
- Hinweis gemäß Bundesdatenschutzgesetz: Die zur Auftragsabwicklung erforderlichen Bestelldaten werden gespeichert.

Stand 06/2017

GENERAL TERMS AND CONDITIONS OF SALE AND DELIVERY

I. General Provisions

1. The provisions of the contract between MEKRA Lang GmbH & Co. KG ("MEKRA Lang") and our orderers who are contractors as defined in para. 14 BGB are solely governed by these General Terms and Conditions. Our offers are exclusively meant for entrepreneurs as defined by Article 4 BGB (German Civil Code). Deviating business terms of the customer, even if they are known to us, shall not become a part of the contract. Our offers are always subject to change without notice. Our General Terms and Conditions of Sale and Delivery are considered accepted upon placement of order, at the latest upon receipt of goods. In the case of repeated business relations these General Terms and Conditions of Sale and Delivery also apply for all future transactions. Should individual provisions be or become completely or partially ineffective, then the validity of the other provisions shall thereby not be affected. MEKRA Lang and the customer shall agree upon a regulation the economic success of which shall be as close as possible to the ineffective one. Until such agreement the laws, administrative practice and judicature effective at the time of execution are to be applied.

II. Conclusion of Contract and Prices

1. By ordering merchandise the customer bindingly declares that he wants to buy the merchandise ordered. He shall be bound to this statement for two weeks. We are entitled to accept the offer of a contract underlying the order within two weeks upon receipt of the latter by us. The acceptance may be declared in writing, electronically, or by delivery of the goods to the customer.

2. The obligations in electronic commerce according to Section 312e, par. 1 sentence 1, Nos. 1 to 3, and sentence 2 of BGB (German Civil Code) are excluded.

3. The conclusion of the contract takes place subject to the correct and timely delivery by our sub-suppliers to us. This applies only in case we are not responsible for the non-delivery, especially in case of the conclusion of a congruent hedging business transaction with our sub-suppliers. The customer shall be informed about the non-availability of the product without delay, and the equivalent, insofar as already paid, shall be reimbursed immediately.

4. All contractual financial obligations are to be fulfilled solely in EURO.

5. Prices are understood to be net as ex factory or supply depot. Freight, packaging and import costs, customs duties and other additional taxes are payable by the customer.

III. Period of Delivery and Supply Commitment

1. Our written or electronic order confirmation shall be decisive for extent, type, and date of the delivery. Partial shipments shall be permitted.

2. A liability in meeting delivery deadlines determined as binding shall only be accepted under the condition of undisturbed flow of operations and distribution. In particular in cases of acts of God and other disruptive events at our facilities or those of our sub-suppliers or transport contractors, for example operational or traffic disruptions, fire, flooding, labour-, energy-, or traffic shortages, strikes, lockouts, official measures as well as technical or technological situations that considerably aggravate the execution of the contract, release us from liability in punctual delivery or give us the right to stop delivery without obligation for subsequent delivery.

3. If not agreed otherwise, we have the right to deliver earlier than the delivery deadline. Unless otherwise agreed upon, delivery effected by us one up to a maximum of two weeks after the stipulated delivery date shall not be considered as delayed.

4. Delivery deadlines shall be considered met when the goods have left the works or dispatch depot or the customer has received notice by expiration of the deadline of our readiness to deliver. Subsequent alteration of contract shall be cause for a reasonable extension of delivery deadlines.

5. In the case of contracts whose performance consists of several deliveries, non-performance, defective or delayed performance of one delivery remains without influence upon the other deliveries of the contract.

6. Default of payments, handing in of a state meant in lieu of an oath of disclosure in accordance with § 807 ZPO (German Code of Civil Procedure), temporary shortage of liquid funds, or public knowledge of a considerable deterioration of the financial circumstances of the customer shall entitle us at our discretion to demand payment in advance for outstanding deliveries or to stop deliveries immediately and to deny performance of current contracts. At the same time we shall be entitled to make immediately due and payable those accounts receivable from the customer which are not due yet.

IV. Shipment, Passage of Risk

1. Unless otherwise agreed by the Parties, the choice of packaging, shipping routes and method of transportation is subject to our discretion.

2. The risk of accidental loss and accidental deterioration of the merchandise shall pass over to the customer upon handing it over, in case of a mail order purchase upon delivery of the matter to the forwarding agent, the carrier, or another person or institution determined to execute the shipment. If the customer is overdue in accepting, this shall be equal to a handing over of the merchandise.

3. Merchandise out of call orders shall be accepted within 3 months after issuance of the acknowledgement of order, unless otherwise agreed.

4. Insurance against breakage and transportation risks shall only be taken out upon special request and shall be billed.

5. Customs duties and other expenses, also the costs for payment of the necessary papers for import into the country of destination, shall be payable by the customer.

V. Payments, Terms of Payment

1. Invoices shall be payable:

- within 14 days from date of invoice with 2 % cash discount of the accumulated invoice value;
- within 30 days from date of invoice without cash discount of the accumulated invoice value.

2. Cash discount shall only be granted after all payment commitments out of earlier deliveries have been fulfilled and the invoice amount has been punctually paid to us in cash or has been credited to our account by the aforementioned due dates. The drawing of a bill of exchange can thus

not lead to the granting of a cash discount. In case of cashless payment, especially when a cheque is submitted, the date of the credit entry shall be decisive. A cash discount cannot be granted in the case of payment or credit entry under reserve, with limiting conditions or any other restrictions. The customer shall assume all risks of method of payment. Invoices for tools are subject to immediate payment without cash discount.

3. Bills of exchange and checks shall only be accepted on account of payment. Corresponding credit entries are made only under the limiting condition of correct receipt of the complete amount due. We reserve the right to take in external or own acceptances. Costs and discount expenses are payable by the customer. We assume no responsibility for submission and protest. Protest imposed against the customer's own bills of exchange or non-immediate repayment of protested external bills of exchange shall entitle us to return all bills in circulation. At the same time we shall be entitled to make immediately due and payable those accounts receivable from the customer which are not yet due. Antedated checks shall not be accepted.

4. Interest on defaulted payment of 9%-points over the discount rate of the German Central Bank referred to in § 247 BGB (German Civil Law) as well as a liquidated damages of 40.00 Euro shall be charged in the case of missed payment dates. The right of assertion of further damages caused by delayed performance and other claims shall remain reserved.

5. Advance and part payments are not subject to interest payments.

6. The customer shall only be entitled to offset or withhold payment if his counterclaim is undisputed or has been determined legally binding. The customer may execute a right of retention only if his counter claim is based on the same contractual relationship.

7. Customer and invoice numbers are to be given by the customer when invoices are balanced. Delays or incorrect booking resulting from failure to do so shall be payable by the customer.

VI. Retention of Ownership, Factoring

1. The delivered goods shall remain our property until payment of all claims has been received. The customer has the right to resell the proviso goods within the scope of proper and orderly course of business; however, a pledge or transfer by way of security is not permissible. The customer is required to ensure our rights in the case of resale of proviso goods on credit.

2. The accounts receivable by the customer based on the resale of the merchandise subject to reservation shall now already be transferred to us in the amount of the invoice. We hereby agree to accept this transfer. Regardless of the assignment, the customer shall retain the right to collect payment under the condition that he fulfils his responsibilities to us according to the underlying contractual relationship and does not fall into financial decline. Otherwise the customer must provide the information about the assignment necessary for collection upon our demand and notify his debtors of the respective assignment. In this case we reserve the right to collect the accounts receivable by ourselves.

3. A possible finishing or processing of the merchandise sold subject to reservation by the customer shall always take place on our behalf and by order of us, without any obligations resulting for us from this, however. In the case of processing of proviso goods with other goods not belonging to us, we are entitled to the co-owner portion of the resulting product corresponding to the value of the proviso goods in relation to the other processed goods. Insofar as here and in the following the value of the proviso goods is referred to, this value results from our invoice value.

4. Should the customer acquire sole ownership of the new product according to § 947 paragraph 2 BGB, it is agreed upon that the customer grants co-ownership in the proportion of the value of the processed, attached, or mixed proviso goods, and that he protects these free of charge.

5. In the case of resale of the proviso goods together with other goods, regardless of with or without processing, attachment or mixing, the assignment in advance agreed to above shall be valid only to the extent of the value of proviso goods that were resold together with the other goods. We shall be obligated to release on demand the securities entitled as provided above, if the value exceeds secured payments by 20 %.

6. The customer must immediately notify us and provide the material necessary for an intervention in the case of compulsory execution by third parties against the proviso goods or in case of claims assigned in advance. Any costs resulting from such intervention shall be payable by the customer.

7. The customer shall be obligated to adequately insure the merchandise sold subject to reservation against fire and burglary and has to prove such insurance to us on demand.

VII. Warranty

1. The period of limitation for any warranty claim shall be 24 months as from handover of the goods.

2. First of all, we shall remedy a defect or make a substitute delivery at our discretion. In case of failure to rectify defects or to substitute delivery, the customer can demand rescission of the contract or reduction of the payment. In case there is only a minor contract violation, especially if there are only minor defects, the customer shall not have the right of contract cancellation, however.

3. The customer must notify us in writing of any obvious flaws immediately, at the latest within 7 days after receipt of the goods, and must refrain from any eventual working of protested goods. Otherwise claims based on defects are excluded. The timely dispatch shall suffice for the observance of the warranty deadline. The full burden of proof for all claim prerequisites rests with the customer, especially for the defect itself, for the date of the establishment of the defect, and for the timeliness of the complaint about the defect.

4. Defects which could not be ascertained within this time span despite careful inspection are to be reported to us in writing immediately upon discovery. If the customer opts for a withdrawal from the contract because of a legal imperfection or a physical defect after a failed subsequent fulfillment, then he shall not be additionally entitled to a claim for compensation because of the defect.

5. If, after a failed subsequent fulfillment, the customer opts for a compensation of the damage, then the merchandise shall remain with the customer if this can reasonably be considered acceptable. The compensation is restricted to the difference between the purchase price and the value of the defective

product. This shall not apply if we caused the contract violation maliciously.

6. Merchandise for which we have effected compensation shall become our property and is to be returned to us against reimbursement of costs.

7. Claims cannot be made for damages that resulted from the customer's culpably

- improper handling or overstressing the purchased item or
- altering the purchased item in a manner not agreed upon or
- not following the instructions of the mounting or operating manual or
- not observing the complaint and delivery responsibility according to points 3 and 4 above or
- further using the purchased item after ascertaining the defect.

Natural wear and tear is excepted from the warranty.

VIII. Liability

1. In case of simply negligent violations of obligations our liability shall be restricted to an average damage predictable for the type of merchandise, typical for such a contract, and immediate. This also applies in case of simply negligent violations of our legal representatives or agents. We shall not be held liable in case of a simply negligent violation of nonessential contractual obligations.

2. The liability by virtue of acceptance of a guarantee as well as due to product liability remains unaffected; the same applies in case of bodily harm or health impairment attributable to us or in the event of loss of life of the customer

3. Compensation claims of the customer because of a defect shall superannuate after one year from the delivery of the merchandise to the customer. This shall not apply if we can be charged with gross negligence as well as in case of bodily harm or health impairment attributable to us or in the event of loss of life of the customer.

IX. Returns

Property ordered and delivered goods shall in principle not be taken back. Returns that have been agreed upon with us shall remain the exception, which additionally require the following pre-requisites to be met:

- The products must have been acquired directly from us or from one of our works depots.
- Flawless and unaltered condition of the goods.
- In principle, return shall only be possible when the articles in question are still in our product range.
- Return shipment must be „free domicile“ to our Ergersheim works or to the appropriate works depot with accompanying delivery note date and number. Value reduction for returns:
 - in the first year after delivery date ./ 10 % of the contract price
 - in the second year after delivery date ./ 25 % of the contract price
 - between the 3rd & the 5th year after deliv. date ./ 50 % of the contract price
 - merchandise over five years old - no return possible
 Technical inspection and completion of the credit slip shall be carried out under consideration of eventual value reduction upon receipt of the articles. Freight costs, insofar as any occurred to us for the original shipping, reduce the remaining value.

X. Industrial Property Rights

1. The customer is held liable to us for the exemption from industrial protection rights of third parties on articles ordered, indemnifies us against any possible claims of third parties and has to reimburse any damage to us possibly resulting from a violation of this obligation.

2. Our designs and design proposals are to be kept confidential and may not be passed on to third parties.

3. All drawings, construction plans, and samples which the customer has received, shall remain our intellectual property.

XI. Place of Fulfillment and Jurisdiction, Other Agreements

1. On principle, the product description of the manufacturer is understood to be decisive for the characteristics of the goods. Public statements, sales talks, or advertisements made apart from this do not represent a contractual description of the characteristics of the goods. Samples and specimens serve as approximate illustrative articles in terms of quality, measurements and colour. Legal claims cannot be inferred from this. Technical changes as well as alterations in shape, colour, and/or weight are reserved within reasonable scope.

2. If the customer receives a faulty assembly instruction, we shall only be obliged to furnish a faultless assembly instruction, and this only if the fault of the assembly instruction is in contradiction with a proper assembly.

3. The customer does not receive warranties in the legal sense of the word from us: warranties of the manufacturers, however, shall remain unaffected by this.

4. Place of fulfillment for our deliveries ex works shall be the delivery works, for delivery ex storage the warehouse. Place of fulfillment for all payments shall be Ergersheim / Bavaria, Germany.

5. The exclusive place of jurisdiction for all litigations from this contract shall be Fuerth / Bavaria, Germany. This also applies to lawsuits based on a cheque or bill of exchange.

6. These provisions shall be governed by the Law of the Federal Republic of Germany. The provisions of the UN Purchase Law shall not be applicable. The wording of the German language version of our „General Terms and Conditions of Sale and Delivery“ shall solely be decisive for these General Business Terms.

7. The special terms of our products published with the appropriate price lists shall additionally be applicable.

8. The customer itself shall be responsible to examine the suitability of the goods for the intended final usage.

9. German law (BDSG-Federal Data Protection Law) requires us to inform you that all data of our customers are electronically saved.

As of: 06/2017



Team Aftermarket

Günther Engel, Marco Wiesmann, Katharina Graf, Yannic Rauner, Sven Felbinger, Sven Gurrath,
(Carina Ixtlahuac-Olsen, nicht im Bild)

Standorte Aftermarkt

Locations for the aftermarket



MEKRALang GmbH & Co. KG
Buchheimer Str. 4
91465 Ergersheim
Germany
Hotline +49 9847 989 8757
Tel +49 9847 989-0
bestellungen@mekra.de
www.mekra.de



MEKRA Lang International ČR. spol. s.r.o
Družstevní 185
33008 Zruč
Czech Republic
Tel +42 0 377 824-893
Fax +42 0 377 824-893
mekra@mekra.cz
www.mekra.cz



MEKRA Lang do Brasil Ltda.
Avenida Paraná 2879
Cajuru do Sul - Sorocoba
SP 18105-000
Brazil
Tel +55 15 3235 3420
Fax+55 15 3235 3421
mekra@mekra.com.br
www.mekra.com.br



MEKRA FRANCE
Bâtiment G
Avenue des Frères Lumière 26 - 32
78190 Trappes
France
Tel +33 30 47 43 85
Fax +33 30 47 45 16
info@mekra.fr
www.mekra.fr



MEKRA Lang North America, LLC
101 Tillessen Boulevard
Ridgeway, SC 29 130
U.S.A.
Tel +1 803 337 52 64
Fax +1 803 337 52 65
sales@lang-mekra.com
http://www.lang-mekra.com



MEKRA UK Limited
17 Willowbrook Road
Ham Bridge Trading
Estate BN14 8NA
Worthing,
Great Britain
Tel +44 1903 206106
Fax+44 1903 214395
info@mekra.co.uk





MEKRA Lang Otomotiv Yan Sanayi A.S.
Baskent Organize Sanayi Bölgesi
19. Cad. No: 60
Maliköy Sincan 06909
Ankara
Turkey
Tel +90 312 640 12 16
Fax +90 312 640 12 25
mekratrurkey@mekra-turkey.com
www.mekra-turkey.com

 **Komplettspiegel (Klasse II / IV)**
complete mirror (class II / IV)
rétroviseur complet (class II / IV)
espeho completo (class II / IV)
specchio completo (class II / IV)
espejo completo (class II / IV)
komplett spegel (class II / IV)
kompletní zrcadlo (trída II / IV)
зеркало в комплекте (класс II / IV)
komple ayna (sinif II / IV)
komplett tükör (II / IV tükörsztály)
kompletne lustra (klasa II / IV)

 **Schraube** **parafuso** **skrv** **vida**
screw **vite** **šroub** **csavar**
vis **tornillo** **virint** **sruba**

 **Kugelstange** **kulstáng**
ball joint **kulový držák**
bras à rotule **šaravaya opora**
Junta de articulación **ayna destekleyicisi**
staffa con snodo a sfera **golyóvégi rúd**
barra con cabeza esférica **pręt z kulką**

 für 1- / 2- / 3- Spiegelbetrieb (Kabel, Schalter)
pour 1- / 2- / 3- mirror operation (cable, switch)
1- / 2- / 3- commande(s) (câble, commutateur)
para 1 / 2 / 3 espehos (cabo, interruptor)
per 1 specchio / 2 specchi / 3 specchi (cavo, interruttore)
servicio de 1- / 2- / 3- espejo(s) (cable, conmutador)
1- / 2- / 3- spegelstyrning (kabel, styrspek)
pro ovládání 1 zrcadla / 2 zrcadel / 3 zrcadel (kabel, ovladač)
для управления 1 зеркалом / управления 2 / 3 зеркалами
1- / 2- / 3- ayna kumandasi (kablo/salter)
1- / 2- / 3- tükör működtetés (vezérlőkábel, állítókapcsoló)
do obsługi 1, 2 lub 3 lusterek (kabele, przełącznik)

 **Spiegelkopf ohne Glaseinheit (Klasse II / IV)**
mirror head without glassunit (class II / IV)
boîtier, sans glace de rechange (class II / IV)
cabeca de espeho sem unidade de vidro (class II / IV)
carcassa senza vetro (class II / IV)
carcasa, sin unidad de cristal (class II / IV)
speghelhuud utan glas (class II / IV)
hlava zrcadla bez skla (trída II / IV)
Зеркала в сборе без зеркального элемента (класс II / IV)
camsız ayna gövdesi (sinif II / IV)
tükörfej tükör és hordozólap nélkül (II / IV tükörsztály)
korpusz lustra bez wkładu (klasa II / IV)

 **Spiegelhalter** **supporto** **несущая опора**
mirror holder **soporte** **ayna tutucusu**
support **hállare** **tükörtartó**
supporte de fixation **držák zrcadla** **uchwył**

 **Stange** **spiegelarm, komplett**
bracket **držák zrcadla**
bras de fixation **трубчатый кронштейн зеркала**
braco de fixação **ayna kolu**
braccio **tükörtartókar**
soporte **wspornik / drążek**

 **manuell verstellbar (Klasse II / IV)**
manually adjustable (class II / IV)
reglage manuel (class II / IV)
manual (class II / IV)
regolazione manuale (class II / IV)
manual (class II / IV)
 **manuell justierbar (Klasse II / IV)**
manuálně ovládané (trída II / IV)
перевыставляемая вручную (класс II / IV)
manuel olarak ayarlanabilen (sinif II / IV)
kezi állítású (II / IV tükörsztály)
regulowane ręcznie (klasa II / IV)

 **Komplettsystem Klasse II + IV inkl. Spiegelstange**
complete system class II + IV incl. bracket
système complet classe II et IV, bras de rétroviseur compris
sistema completo classe II + IV, suporte incluso
sistema completo classe II + IV completo di braccio
sistema completo classe II + IV, brazo incluido
komplett system class II + IV inkl. spegelbágar
kompletní systém třídy II + IV včetně držáku zrcadla
Системы класса II + IV включая кронштейн зеркала
komple sistem sinif II + IV tutucu dahil
komplett rendszer II és IV-es osztályú tükörökkel és karral
kompletny system klasy II + IV + ramie lustra

 **Scharnier** **rótula** **knävel** **mafsal**
hinge **cerniera** **záves** **csulópánt**
charnière **rotula** **шарнир** **zawias**

 **Haltebock** **nedre hållare**
lower holder **spodni držák**
support de fixation **держатель**
supporte inferior de fixação **tutucu**
supporto inferiore **csukló**
supporte bajo **uchwył**

 **elektrisch verstellbar (Klasse II / IV)**
remote controlled (class II / IV)
réglage électrique (class II / IV)
elétrico (class II / IV)
regolazione elettrica (class II / IV)
elétrico (class II / IV)
 **elektrisch justierbar (Klasse II / IV)**
elektricky ovládané (trída II / IV)
электрорулеваемое (класс II / IV)
uzaktan kumandalı (sinif II / IV)
elektromosan állítható (II / IV tükörsztály)
regulowane elektrycznie (klasa II / IV)

 **Busspiegel mit Gelenkarm**
bus mirror with joint arm
rétroviseur de car avec bras articulé
espeho para ônibus com braço articulado
specchio per autobus con braccio snodabile
retrovisor para autocar con brazo articulable
busspiegel med ledar arm
zrcadlo autobusu s kloubovým ramenem
зеркало для автобуса
otobüs aynası
busztükör csuklós karral
lustra autobusu na ramieniu przegubowym

 **Adapter** **adaptador** **adapter** **adaptör**
adapter **adattatore** **adaptér** **adapter**
adaptateur **adaptador** **переходник** **adapter**

 **Aufsteckkeil** **monteringskil**
mounting wedge **nástrčný klin**
semelle de fixation **установочный клин**
cunha desmontável **bağlantı parçası**
supporto a cuneo **ékes csatlakozó**
cunha desmontable **klin do mocowania**

 **Memory-Funktion (Speicherung der Spiegeleinstellung)**
memory function (storage of the position of the mirror)
fonction de mémoire (pour réglage du rétroviseur)
função Memória (memoriza a posição do espeho)
funzione memoria (della posizione dello specchio)
función de memoria (de la posición del espejo)
minnesfunktion (lagring av inställningar)
функция сохранения (мемори)
hafıza fonksiyonu (ayna pozisyonu için)
memória funkcióval (tükör beállításá mentve)
funkcja pamięci (pamięć ustawienia)

 **Busspiegel, hängend**
bus mirror, pendant mounting
rétroviseur de car, montage suspendu
espeho para ônibus com montagem em posição invertida
specchio per autobus, montaggio appeso
retrovisor para autocar, montaje en posición invertida
busspegel, hängande
zrcadlo autobusu visící
зеркало для автобуса, свисающее
otobüs aynası, asılır tip
busztükör függő
lustra autobusu wiszące

 **Aufsteckkeil mit Direktkontakt**
mounting wedge with direct contact
semelle de fixation avec contact direct
cunha desmontável com elemento de contato direto
supporto a cuneo con contatto diretto
cunha desmontable com elemento de cont. directo
monteringskil med direktkontakt
nástrčný klin s přímým kontaktem
установочный клин с прямым электроконтактом
direk temaslı bağlantı parçası
ékes csatlakozó direkt kontaktussal
klin do mocowania z bezpośrednio kontaktem

 **manuell abklappbar**
manually retractable
rabattable manuellement
espeho retrátil manual
ripiegabile manualmente
ababile manualmente
manuellt infällbar
manuálně sklápny
перевыставляется вручную, откидное
manuel olarak katlanabilme
kézzel behajtható
 ręcznie składane

 **Busspiegel, stehend**
bus mirror, upright mounting
rétroviseur de car, montage posé
espeho para ônibus com montagem em pé
specchio per autobus, montaggio verticale (ritto)
retrovisor para autocar, montaje en posición de pie
busspegel, stående
zrcadlo autobusu stojící
зеркало для автобуса, стоячее
otobüs aynası, dik tip
busztükör álló
lustra autobusu stojące

 **Faltenbalg** **gummibalg**
rubber boot **manžeta**
soufflet de protection **резиновая гофра**
carregador de borracha **körük**
soffietto **gumiharmonika**
guardapolvo **ostona / manczeta**

 **Heizkabel, 2 polig (runder / ovaler Winkelstecker)**
heating cable, double pole (right angle connector, round / oval)
câble chauffant, bipolaire (connexion fiche coudée ronde / ovale)
cabo de aquecimento, bipolar (pino lateral, redondo / ovalado)
cavo, bipolare (attacco 90°, rotondo / ovale)
cable de calefacción, bipolar (clavija lateral, redondo / ovalado)
kabel für uppvärmning, 2-polig (vinkelkontakt rund / oval)
vyhřívací kabel, 2-pólový (kruhová / oválná úhlová zástrčka)
кабель подкл. нагревателя, двухполюсной,
(круглая угловая вилка /)
ısıtıcı kablo, çift kutup (dik açılı konektör, yuvarlak / oval)
2 poltusa fűtőkábel ovális / kerek csatlakozóval
przewód grzejny, 2 pin (okrągłe / owalne, wtyczka pod kątem)

 **elektrisch abklappbar**
electrically retractable
rabattable électriquement
espeho retrátil eléctrico
ripiegabile elettricamente
ababile elettricamente
elektriskt infällbar
elektricky sklápny
перевыставляется электр., откидное
motorlu olarak katlanabilme
elektromosan behajtható
elektrycznie składane

 **Glaseinheit (Klasse II / IV)**
glass unit (class II / IV)
glace sur support plastique (class II / IV)
unidade de vidro (class II / IV)
vetro con supporto in plastico (class II / IV)
unidad de cristal (class II / IV)
 **glas på platta (Klasse II / IV)** **sklo s deskou (trída II / IV)**
зеркальный элемент с подножкой держателя (класс II / IV)
ayna camı, plastik muhafazalı (sinif II / IV)
tükör hordozólapjal (II / IV tükörsztály)
wkład lustra (klasa II / IV)

 **Steuerkabel** **kabel för elstyrning**
control cable **ovládací kabel**
câble de commande **кабель управления**
cabo de controle **kontrol kablou**
cavo di controllo **vezérlőkábel**
cable de control **kabel strowania**

 **Versorgungsleitung** **elkabel**
supply cable **živojový kabel**
câble d'alimentation **провод питания**
cabo de alimentación **besleme kablou**
cavo di alimentazione **betápkábel**
cable distribuidor **przewód zasilania**

 **beheizt (12 / 24 Volt)**
heated (12 / 24 Volt)
chauffant (12 / 24 Volt)
aquecido (12 / 24 Volt)
iscaldato (12 / 24 Volt)
calefactado (12 / 24 Volt)
med värme (12 / 24 Volt)

 **Spannung (12 / 24 Volt)**
voltage (12 / 24 Volt)
voltage (12 / 24 Volt)
voltage (12 / 24 Volt)
tensione (12 / 24 Volt)
voltaje (12 / 24 Volt)

 **spänning (12 / 24 Volt)**
napětí (12 / 24 Volt)
напряжение (12 / 24 вольт)
volt (12 / 24 Volt)
 feszültség (12 / 24 Volt)
 napięcie (12/24 V)

 **Ersatzglas** **vetro di ricambio** **запасное стекло**
spare glass **cristal de repuesto** **ayna camı**
glace de rechange **reservglas** **csere tükörleap**
vidro de reposição **náhradní sklo** **szkło wymienne**

 **Heizfolie** **värmeelement**
heating foil **vyhřívací fólie**
feuille chauffante **нагревательный элемент**
manta aquecedora **ısıtıcı folyo**
resistenza **fűtőfólia**
lámina de calefacción **mata grzewcza**

 **Spiegelverstellungsschalter** **stýrspak**
mirror switch **ovládač zrcadel**
commutateur de rétroviseur **blok управления**
interruptor do espeho **ayna kumanda düğmesi**
interruptore **tükörállító kapcsoló**
comutador de espejo **przełącznik regulacji**

 **Leistungsaufnahme (Watt)**
power consumption (Watt)
puissance en watt
consumo de energia (Watt)
potenza (Watt)
consumo de energia (wattios)

 **strömförbrning (Watt)**
píkon (Watt)
потребляемая мощн. (ватт)
güç tüketimi (Watt)
teljesítmény (watt)
pobór mocy (wat)

 **Abdeckung (Klasse II / IV)**
back cover (class II / IV)
cache (class II / IV)
cobertura traseira (class II / IV)
calotta (class II / IV)
pared dorsal (class II / IV)

 **bakstycke (class II / IV)**
zadní kryt (trída II / IV)
задняя крышка корпуса (класс II / IV)
arka kapak (sinif II / IV)
burkolat (II / IV tükörsztály)
pokrywa lustra (klasa II / IV)

 **kompletter Kabelsatz für elektrisch verstellbare Spiegel**
complete cable set for remote controlled mirrors
kit complet pour réglage électrique
kit completo de cabos para espehos elétricos
set di cavi per specchi elettrici
juego completo de cables para espejos eléctricos
kabelszat für eljusterbara speglar
kompletní kabelová sada pro elektricky ovládaná zrcadla
полный комплект кабелей с блоком управления для электрорулеваемых зеркал
uzaktan kumandalı aynalar için kablo seti
komplett kabelköteg elektromosan állítható tükörkhöz
komplet kabló do lustra sterowanego elektrycznie

 **Wölbungsradius des Spiegelglases**
radius of shading of the mirror glass ("plan" = flat)
rayon de convexité du verre ("plan" = plat)
Raio de convexidade do vidro ("plan" = plano)
raggio di curvatura dello specchio ("plan" = piano)
radio de convexidad del cristal ("plan" = plano)
böjningsradie på spegelglas („plan" = plöskig)
polomér zakřivení skla zrcadla ("plan" = ploché)
радиус кривизны стекла зеркала („plan" = плóский)
bükmény sugarai ("plan" = düz)
tükör hajlítási sugara („plan" = sík tükör)
promień krzywizny szkła lustra („plan" = płaski)

 **Rahmen** **aro** **ram** **çerçeve**
frame **cornice** **rám** **keret**
cadre **marco** **рама** **rama**

 **Getriebe** **motor** **motor** **motor**
actuator **attuateur** **motorek** **hajtómű**
moteur **motor** **электрпривод** **tryby sterujące**

 **Blinker (-Gehäuse)** **körriktningsvisare**
indicator (housing) **blinker**
clignotant **указатель поворота**
luz de seta (com capa) **sinyal lamba yuvası**
freccia (lampeggiatore) **index (ház)**
intermittente **obudowa kierunkowskazu**

 **asphärisch** **asferico** **асферическое**
aspherical **esférico** **асферік**
non-sphérique **asfärisck** **асферичне**
esférico **asférică**

 **Farbe schwarz / grau / chrom**
colour black / grey / chrome
couleur noire / grise / chrome
cor preto / cinza / cromado
coloro nero / grigio / cromo
color negro / gris / cromo
färg svart / grå / krom
barva černá / šedivá / chromová
цвет: чёрный / серый / хром
renk siyah / gri / krom
fekete / szürke / króm színben
 kolor: czarny / szary / chromowy

Anbau • mounting • assemblage • montagem • montaggio • montaje
montering • montáž • монтаж • montaj • gyűlékezés • montáz

Verwendung • application • aplicação • applicazione • aplicación
osňokan • použití • применение • Kullanimi • alkalmazás • aplicacja

links / rechts einsetzbar
applicable for left / right hand side
applicable à gauche / à droite
aplicável para esquerda / direita
per applicazione sinistro / destro
aplicable para izquierda / derecha
justerbar vänster / höger
použitelné pro levou i pravou / levou/pravou stranu
для применения слева / справа
sol ve sağ tarafta kullanilabilen / sol/sağ tarafta kullanilabilen
bal / jobb oldalra felszerelhető
montáz: strana lewa / prawa

Anbau oben / unten
mounting top / bottom
montage haut / bas
montagem superior / inferior
montaggio superiore / inferiore
montaje superior / inferior
Montering upp / ned
montáž nahoru / dolů
монтаж сверху / снизу
montaj üst / alt
felül / alul szerelt
montáz góra / dót

für links / rechts gesteuerte Fahrzeuge
for left / right hand driven vehicles
pour véhicules conduites à gauche / à droite
para veículos conduzidos pela esquerda / direita
per veicoli con guida sinistra / destra
para vehiculos conducidos a la izquierda / a la derecha
föer vänster / högerstyrda fordon
pro levo / pravostranné řízená vozidla
для автомобилей с рулём слева / справа
sol ve sağdan direksiyonlu araçlar için
soldan / sağdan direksiyonlu araçlar için
bal / jobb oldalt vezetett járművekhez
dla ruchu lewo i prawo stronnego

links einsetzbar für rechts gesteuerte Fahrzeuge
applicable left hand side for right hand drive vehicles
applicable à gauche pour véhicules conduites à droite
aplicável para esquerda / veículos conduzidos pela direita
per applicazione sinistro per veicoli con guida destra
aplicable para izquierda / vehiculos conducidos a la derecha
justerbar vänster för högerstyrda fordon
použitelné pro pravou stranu pro levostranné řízená vozidla
для применения справа, в автомобиле с рулём слева
sağdan direksiyonlu araçlar için sol tarafta kullanilabilen
bal oldalra felszerelhető, jobb oldalon vezetett járművekhez
strona lewa dla ruchu prawostronnego

rechts einsetzbar für links gesteuerte Fahrzeuge
applicable right hand side for left hand drive vehicles
applicable à droite pour véhicules conduites à gauche
aplicável para direita / veículos conduzidos pela esquerda
per applicazione destro per veicoli con guida sinistra
aplicable para derecha / vehiculos conducidos a la izquierda
justerbar höger för vänsterstyrda fordon
použitelné pro pravou stranu pro levostranné řízená vozidla
для применения справа, в автомобиле с рулём слева
soldan direksiyonlu araçlar için sağ tarafta kullanilabilen
jobb oldalra felszerelhető, bal oldalon vezetett járművekhez
strona lewa dla ruchu lewostronnego

links einsetzbar für links gesteuerte Fahrzeuge
applicable left hand side for left hand drive vehicles
applicable à gauche pour véhicules conduites à gauche
aplicável para esquerda / veículos conduzidos pela esquerda
per applicazione sinistro per veicoli con guida sinistra
aplicable para izquierda / vehiculos conductos a la izquierda
justerbar vänster för vänsterstyrda fordon
použitelné pro levou stranu pro levostranné řízená vozidla
для применения слева, в автомобиле с рулём слева
soldan direksiyonlu araçlar için sol tarafta kullanilabilen
jobb oldalra felszerelhető, bal oldalon vezetett járművekhez
strona lewa dla ruchu lewostronnego

rechts einsetzbar für rechts gesteuerte Fahrzeuge
applicable right hand side for right hand drive vehicles
applicable à droite pour véhicules conduites à droite
aplicável para direita / veículos conduzidos pela direita
per applicazione destro per veicoli con guida destra
aplicable para derecha / vehiculos conductos a la derecha
justerbar höger för högerstyrda fordon
použitelné pro pravou stranu pro pravostranné řízená vozidla
для применения справа, в автомобиле с рулём справа
sağdan direksiyonlu araçlar için sağ tarafta kullanilabilen
jobb oldalra felszerelhető, jobb oldalon vezetett járművekhez
strona lewa dla ruchu lewostronnego

Fahrzeugbreite
width of vehicle
largeur de véhicule
largura do veículo
larghezza del veicolo
anchura del vehículo
fordonsbredd
šířka vozidla
ширина автомобиля
araç genişliği
járműlélességig
szerozőségi
szerozőségi
szerozőségi
szerozőségi

Anbau am Türrahmen
mounting on the door frame
montage cadre portière
montado na porta
montaggio su cornice porta
montaje en el marco de la puerta
montering på dörrkarm
montáž na rám dveří
монтаж на раму двери
araç kapı çerçevesine montaj
ajtkeretre szerelhető
montaż na drzwiach

integrierter Halter
integrated holder
support intégré
suporte de fixação integrado
supporto integrato
soporte integrado
integrerad hållare
integrovaná montáž
интегрированный
tűmlesztés
ayna tutucusu
integrált tartó
zintegrowany uchwył

Winkelstellung
angularity
angle of fixation
ángulo
angolatura
angularidad
vinkel
űhel nastaveni
yról
açı pozisyonu
szögállás
położenie
kątowe

Material • matériel • materiale • material
материал • materiyal • anyag • materiał

Spiegelgehäuse: Kunststoff ABS (schwarz / grau)
mirror housing: plastic ABS (black / grey)
boîtier: matière plastique ABS (noir / argenté)
carcaça: plástico ABS (preto / cinza)
carcassa: plastica ABS (nero / grigio)
carcasa: plástico ABE (negro / gris)
spegelhus: plast ABS (svart / grå)
skořepina zrcadla: umělá hmota ABS (černá / šedivá)
корпус зеркала: пластмасса ABS (цвет чёрный / серый)
ayna gövdesi plastik ABS (siyah / gri)
tükörház ABS-ből (fekete / szürke)
obudowa lustra: tworzywo ABS (kolor czarny / szary)

Spiegelgehäuse: Kunststoff ASA, schwarz
mirror housing: plastic ASA, black
boîtier: matière plastique ASA, noir
carcaça: plástico ASA, preto
carcassa: plastica ASA, nero
carcasa: plástico ASA, negro
spegelhus: plast ASA, svart
skořepina zrcadla: umělá hmota ASA, černá
корпус зеркала: пластмасса ASA, цвет чёрный
ayna gövdesi plastik ASA, siyah
tükörház ASA-ből, fekete
obudowa lustra: tworzywo ASA, kolor czarny

Spiegelgehäuse: Kunststoff PP (Polypropylen), schwarz
mirror housing: plastic PP (polypropylene), black
boîtier: matière plastique PP (polypropylène), noir
carcaça: plástico PP (polipropileno), preto
carcassa: plastica PP (polipropilene), nero
carcasa: plástico PP (polipropileno), negro
spegelhus: plast PP (polypropylen), svart
skořepina zrcadla: umělá hmota PP (Polypropylen), černá
корпус зеркала: пластмасса Полипропилен, цвет чёрный
ayna gövdesi plastik PP (Polipropilen), siyah
tükörház PP-ből, fekete
obudowa lustra: tworzywo PP (polipropylen), kolor czarny

Spiegelgehäuse: Kunststoff PC (Polycarbonat) schwarz
mirror housing: plastic PC (Polycarbonat) black
boîtier: matière plastique PC (Polycarbonat) noir
Carcaça: plástico PC (Polycarbonato) preto
carcassa: plastica PC (Polycarbonato) nero
carcasa: plástico PC (Polycarbonato) negro
spegelhus: plast PC (Polycarbonat) svart
skořepina zrcadla: umělá hmota PC (Polycarbonat) černá
корпус зеркала: пластмасса Поликарбонат, цвет чёрный
ayna gövdesi plastik polycarbonat siyah
tükörház PP-ből, fekete
obudowa lustra: tworzywo PC (poliwęglan), kolor czarny

Spiegelstange umschäumt mit PU (Polyurethan)
mirror bracket foamed with PU (polyurethan)
le bras du rétroviseur est recouvert de polyuréthane
Braço revestido de espuma sintética PU (Poliuretano)
braccio schiumato con PU (polyuretan)
brazo revestido de espuma sintética PU (Polyuretano)
spiegelarm i skumformad PUR (polyuretan)
trubka držáku zpětného zrcadla zalisovaná v Polyurethanu
брус зеркала покрытый ПУ (полиуретаном)
ayna kolu polyüretan kaplı
tükörtartó kar habosított PU-val borítva
ramię lustra wyściętane PU (poliuretana)

verzinktes Stahlblech
galvanized sheet steel
boîtier en tôle zinguée
chapa de aço galvanizada
acciaio zincato
carcasa de chapa de acero galvanizada
galvaniserad plát
pozinkovaný plech
оцинкованная листовая сталь
galvanizált metal plaka
horganyzott acéllemez
blacha ocynkowana

Stahlrohr
steel tube
tube en acier
tubo de aço
tubo in acciaio
tubo de acero
stálrör
ocelová trubka
стальная трубка
çelik boru
acélcső
rura stalowa

Alu
aluminium tube
tube en aluminium
tubo de aluminio
tubo de aluminio
aluminiumrör
hliníková trubka
алюминиевая трубка
alüminyum boru
alucső
rura aluminiowa

Zeitraum • space of time • espace de temps • período de tempo
período de tempo • espacio de tiempo • period • období
период времени • dőnem • időbeni kiterjesztés • okres czasu

verwendbar ab Baujahr ... des Fahrzeugs (Monat / Jahr)
usable from year of production ... of the vehicle (month / year)
utilisable à partir de l'année ... du véhicule (mois / an)
aplicado a partir da data de produção do veículo (mês / ano)
utilizzabile dall'anno di produzione del veicolo (mese / anno)
utilizable desde el año de fabricación del vehículo (mes / año)
användbar för fordon med produktionsår from (månad / år)
použitelné od roku výroby vozidla (měsíc / rok)
применять до ... года изготовления (год / месяц)
Aracın üretim yılından sonra kullanilabilir (ay / yıl)
alkalmazható ... évjáratig (év / hónap)
rok budowy pojazdu od ... (miesiąc / rok)

verwendbar bis Baujahr ... des Fahrzeugs (Monat / Jahr)
usable until year of production ... of the vehicle (month / year)
utilisable jusqu'à l'année ... du véhicule (mois / an)
aplicado até a data de produção do veículo (mês / ano)
utilizzabile fino all'anno di produzione del veicolo (mese / anno)
utilizable hasta el año de fabricación del vehículo (mes / año)
användbar för fordon med produktionsår to (månad / år)
použitelné do roku výroby vozidla (měsíc / rok)
применять до ... года изготовления (год / месяц)
Aracın üretim yılına kadar kullanilabilir (ay / yıl)
alkalmazható ... évjáratig (év / hónap)
rok budowy pojazdu do ... (miesiąc / rok)

Zeitraum
space of time
espace de temps
período de tempo
periodo de tempo
espacio de tiempo
period
obdobi
период времени
dőnem
időbeni kiterjesztés
okres czasu

Spiegelklassen • mirror classes • classes de rétroviseurs • classes de espelhos
classi di specchio • classes de rétroviseurs • spegellasser • třídy zrcadel
классы зеркал • ayna siniflari • tükörsztályok • klasy luster

Spiegelklasse I (Innenspiegel)
mirror class I (interior mirror)
rétroviseur classe I (miroir intérieur)
espelho classe I (espelho interior)
specchio classe I (specchio interno)
espejo clase I (espejo interior)
spegelklass I (innerspegel)
zrcadlo třídy I (zrcadlo vnitřní)
зеркало класс I (внутреннее зеркало)
sinif I ayna (açı ayna)
I tükörsztály (belső tükör)
lustra klasy I (wsteczne)

Spiegelklasse II / III (Hauptspiegel)
mirror class II / III (main mirror)
rétroviseur classe II / III (rétroviseur principal)
espelho classe II / III (espelho principal)
specchio classe II / III (retrovissore principale)
espejo clase II / III (espejo principal)
spegelklass II / III (huvudspegel)
zrcadlo třídy II / III (zrcadlo hlavní)
зеркало класс II / III (главное зеркало)
sinif II / III ayna (ana ayna)
II / III tükörsztály (főtükör)
lustra klasy II / III (główna)

Spiegelklasse IV (Weitwinkelspiegel)
mirror class IV (wide angle mirror)
rétroviseur classe IV (rétroviseur grand angle)
espelho classe IV (espelho auxiliar)
specchio classe IV (coppa grandangolo)
espejo clase IV (espejo de gran ángulo)
spegelklass IV (vidvinkelspegel)
zrcadlo třídy IV (zrcadlo širokouhlé)
зеркало класс IV (широкоугольное зеркало)
sinif IV ayna (geniş görüş aynası)
IV tükörsztály (nagy látószögű tükör)
lustra klasy IV (szerokokątne)

Spiegelklasse V (Rampenspiegel)
mirror class V (roof mirror)
rétroviseur classe V (miroir d'accostage)
espelho classe V (espelho de rampa)
specchio classe V (specchio guardaruota)
espejo clase V (espejo de rampa)
spegelklass V (närskiktspegel)
zrcadlo třídy V (zrcadlo rampové)
зеркало класс V (зеркало для рамы)
sinif V ayna (kapı üstü aynası)
V tükörsztály (rampatükör)
lustra klasy V (rampowe)

Spiegelklasse VI (Frontspiegel)
mirror class VI (front-under mirror)
rétroviseur classe VI (miroir frontal)
espelho classe VI (espelho frontal)
specchio classe VI (guardaruota anteriore)
espejo clase VI (retrovisor para parte frontal del vehículo)
spegelklass VI (frontspiegel)
zrcadlo třídy VI (zrcadlo čelní)
зеркало класс VI (фронтальное зеркало)
sinif VI ayna (ön tapın aynası)
VI tükörsztály (fronttükör)
lustra klasy VI (przednie)

Spiegelsystem Klasse II + IV
(Hauptspiegel + Weitwinkelspiegel)
mirror system class II + IV
(main mirror + wide angle mirror)
système de rétroviseurs classe II + IV
(rétroviseur principal + rétroviseur grand angle)
espelho classe II + IV
(espelho principal + espelho auxiliar)
sistema di specchi classe II + IV
(retrovissore principale + coppa grandangolo)
sistema de retrovisores classe II + IV
(espejo principal + espejo de gran ángulo)
spiegelsystem klass II + IV
(huvudspegel + vidvinkelspegel)
systém zpětných zrcadel třídy II + IV
(zrcadlo hlavní + zrcadlo širokouhlé)
Система зеркал класс II + IV
(главное + широкоугольное зеркало)
sinif II + IV ayna sistemi
(ana ayna + geniş görüş aynası)
tükörrendszér II és IV osztályok tükörökkel
(fő és nagy látószögű tükörökkel)
system lusterek klasy II + IV
(główna + szerokokątne)

Spiegelsystem Klasse II + V
(Hauptspiegel + Rampenspiegel)
mirror system class II + V
(main mirror + roof mirror)
système de rétroviseurs classe II + V
(rétroviseur principal + miroir d'accostage)
espelho classe II + V
(espelho principal + espelho de rampa)
sistema di specchi classe II + V
(retrovissore principale + specchio guardaruota)
sistema de retrovisores classe II + V
(espejo principal + espejo de rampa)
spiegelsystem klass II + V
(huvudspegel + närskiktspegel)
systém zpětných zrcadel třídy II + V
(zrcadlo hlavní + zrcadlo rampové)
Система зеркал класс II + V
(главное + зеркало для рамы)
sinif II + V ayna sistemi
(ana ayna + kapı üstü aynası)
tükörrendszér II és V osztályok tükörökkel
(fő és rampa tükörökkel)
system lusterek klasy II + V
(główna + rampowe)

EGE - / ECE - gerecht
according to EEC-norm
conforme aux normes / CE
conforme normas da CE
a norma CEE
conforme a las normas CE
EG-godkänd
splňuje normy EU
соответствует нормам ECE
EEC normlarına uygundur
EG / ECE - nek megfelelő
zgodne z EC / ECE

Katalogseite
catalogue page
page du catalogue
página do catálogo
oldal a katalógusban
pagina catálogo
Katalogsida
strana katalogu
strаница каталога
katalóg sayfasi
oldal a katalógusban
strona w katalogu

MEKRA Lang - **passion** for excellence.

Contents are subject to change
Last Update: September 2022
www.mekra.de

